



**MECHANICAL ENGINEERING DEPARTMENT FINAL
REPORT**

TURN OFF SIGNAL ALERT SYSTEM

DJJ40182 - PROJECT 2

SESSION: 1 2022/2023

LECTURER'S NAME	MOHD ZULKARNAEN BIN MOHD IBRAHIM
STUDENT'S NAME	MUHAMMAD AKMAL BIN ROSZAHAN (08DMP20F2012) MUHAMMAD IRHAM BIN ABDUL RAHIM (08DMP20F2006) MUKEISH KUMAR A/L N HARE HARAN (08DMP20F2008)
CLASS	DMP5A



MECHANICAL ENGINEERING DEPARTMENT FINAL REPORT

TURN OFF SIGNAL ALERT SYSTEM

DJJ40182 – PROJECT 2

SESSION: 1 2022/2023

This report is submitted to the Department of Mechanical Engineering in partial fulfilment of the requirements for Diploma in Mechanical Engineering

LECTURER'S NAME	MOHD ZULKARNAEN BIN MOHD IBRAHIM
STUDENT'S NAME	MUHAMMAD AKMAL BIN ROSZAHAN (08DMP20F2012) MUHAMMAD IRHAM BIN ABDUL RAHIM (08DMP20F2006) MUKEISH KUMAR A/L N HARE HARAN (08DMP20F2008)
CLASS	DMP5A

DECLARATION OF ORIGINALITY AND OWNERSHIP

TITLE: Turn Off Signal Alert System

- | | | |
|--------|-----------------------------------|----------------|
| 1. We, | 1. Mukeish Kumar A/L N Hare Haran | (08DMP20F2008) |
| | 2. Muhammad Irham Bin Abdul Rahim | (08DMP20F2006) |
| | 3. Muhammad Akmal Bin Roszahan | (08DMP20F2012) |

Are final year students of Diploma in Mechanical Engineering, **Department of Mechanical Engineering, Politeknik Sultan Salahuddin Abdul Aziz Shah**, which is located at Persiaran Usahawan, 40150 Shah Alam, Selangor.

2. We recognize that the 'project on' and intellectual property contained in it is the work/design of our original without taking or imitating any intellectual property rights of other parties.

3. We agreed to relinquish ownership of the intellectual property 'project' to 'Polytechnic' to meet the needs of the award of Diploma in Mechanical Engineering to us.

Done and truthfully recognized by the;

- | | |
|--|-------------------------|
| a) MUKEISH KUMAR A/L N HARE HARAN
(NO IC: 020520-10-2165) | _____
MUKEISH KUMAR |
| b) MUHAMMAD IRHAM BIN ABDUL RAHIM
(NO IC: 020306-11-0607) | _____
MUHAMMAD IRHAM |
| c) MUHAMMAD AKMAL BIN ROSZAHAN
(NO IC: 020726-01-0557) | _____
MUHAMMAD AKMAL |

Infront of me, MOHD ZULKARNAEN BIN MOHD IBRAHIM

(790318-07-5141) as the supervisor on the

date:

MOHD ZULKARNAEN
BIN MOHD IBRAHIM

STUDENT INFORMATION

Name	MUKEISH KUMAR A/L N HARE HARAN
Matric No	08DMP20F2008
Programme/ Class	DIPLOMA IN MECHANICAL ENGINEERING (PACKAGING) / DMP5A
Contact No	013-3027062
Email	mukeishk@gmail.com



Name	MUHAMMAD AKMAL BIN ROSZAHAN
Matric No	08DMP20F2012
Programme/ Class	DIPLOMA IN MECHANICAL ENGINEERING (PACKAGING) / DMP5A
Contact No	011-56780585
Email	muhammadakmalroszahan@gmail.com



Name	MUHAMMAD IRHAM BIN ABDUL RAHIM
Matric No	08DMP20F2006
Programme/ Class	DIPLOMA IN MECHANICAL ENGINEERING (PACKAGING) / DMP5A
Contact No	010-9379171
Email	irhamrahim06@gmail.com



ACKNOWLEDGEMENT

First and foremost, we would want to express our thankfulness to God for providing us with the chance to accomplish this research and project. This project serves as a link between theoretical and practical activity. We have worked hard on this project. However, it would not have been feasible without the support and assistance of several individuals and organizations. We want to express our heartfelt gratitude to each and every one of them.

We would like to express our sincere gratitude to several individuals and organizations for supporting us throughout our graduate study. First, we wish to express our sincere gratitude to my supervisor, En Zulkarnaen Bin Mohd Ibrahim, for his enthusiasm, patience, insightful comments, helpful information, practical advice, and unceasing ideas that have helped us tremendously at all times in our research and writing of this thesis. His immense knowledge, profound experience and professional expertise in Data Quality control have enabled us to complete this research successfully. Without his support and guidance, this project would not have been possible. We could not have imagined having a better supervisor in our study.

We are also glad to our course mate who provided strong moral support that assisted us in finishing this report, who contributed ideas in certain parts, and who assisted us in completing this report. This result would not have been achieved without their unending assistance in finishing this report. Thank you for your extremely helpful advice and comments as we do research and study for our project 'Turn Off Signal Alert System'.

ABSTRACT

Road crashes are serious concerns globally as they claim and cause more than 1.35 million fatalities and up to 50 million resulting injuries each year. Previous studies showed that the causes of road crashes are multifactorial, with human error contributing to approximately more than two-thirds of all road crashes, particularly in developing countries. One of the causes of vehicle crashes is failure to turn off turn signals after a turn by motorists. Not only that, but motorists forgetting to turn off their turn signal can make other road users also think that a motorist will be turning or might pull out in front of them, and this can increase the risk of accidents to happen. Nowadays, when motorcyclists turn on their turn signal, they often forget to turn it off after a turn, which can confuse other people on the road and cause accidents. After monitoring and researching about this issue, a turn signal alert system with the function to notify all motorists to turn off their turn signal is designed to solve this issue. The objective of this project is to create a turn off signal alert system that uses vibration to notify motorists to turn off their turn signal and to reduce accidents involving motorcyclists forgetting to turn off their signal. The concept design for turn off signal alert system was chosen based on the suitability, cost and research that has been done. The invention was made with an appropriate method, using the coin vibrator as the main component for this project. The activation of the vibrator has been conducted at the handle of the motorcycle to help the riders notice that their turn signal light is still on. The vibrator will activate when the motorist turns on their turn signal and will continue to vibrate until the turn signal is turned off.

ABSTRAK

Kemalangan jalan raya ialah kebimbangan serius di seluruh dunia kerana ia mendakwa dan menyebabkan lebih 1.35 juta kematian dan sehingga 50 juta kecederaan setiap tahun. Kajian terdahulu menunjukkan bahawa punca kemalangan jalan raya adalah kepelbagaian faktor, dengan kesilapan manusia menyumbang kepada kira-kira dua pertiga daripada semua kemalangan jalan raya, terutamanya di negara membangun. Salah satu punca kemalangan kenderaan adalah kegagalan untuk mematikan lampu isyarat selepas belok oleh pemandu. Bukan itu sahaja, malah pengguna jalan raya yang terlupa mematikan isyarat membelok boleh membuatkan pengguna jalan raya lain turut beranggapan bahawa seseorang pemandu akan membelok atau mungkin menarik diri di hadapan mereka, dan ini boleh meningkatkan risiko kemalangan berlaku. Kini, apabila penunggang motosikal menghidupkan isyarat belok, mereka sering terlupa untuk memamatkannya selepas selekoh yang boleh mengelirukan orang lain di jalan raya dan menyebabkan kemalangan. Selepas memantau dan meneliti tentang isu ini, sistem amaran isyarat belok dengan fungsi untuk memberitahu semua pemandu untuk mematikan isyarat belok mereka direka untuk menyelesaikan masalah ini. Objektif projek ini adalah untuk mewujudkan sistem amaran isyarat mematikan yang menggunakan getaran untuk memberitahu pemandu supaya mematikan isyarat belok mereka dan untuk mengurangkan kemalangan yang melibatkan penunggang motosikal terlupa mematikan isyarat mereka. Reka bentuk konsep sistem amaran mematikan isyarat dipilih berdasarkan kesesuaian, kos dan kajian yang telah dilakukan. Ciptaan ini dibuat dengan kaedah yang sesuai, menggunakan penggetar syiling sebagai komponen utama untuk projek ini. Pengaktifan vibrator telah dijalankan pada pemegang motosikal bagi membantu penunggang menyedari bahawa lampu isyarat membelok mereka masih menyala. Vibrator akan diaktifkan apabila pemandu menghidupkan isyarat belok mereka dan akan terus bergetar sehingga isyarat belok dimatikan.

TABLE OF CONTENT

DECLARATION OF ORIGINALITY AND OWNERSHIP	3
ACKNOWLEDGEMENT	5
ABSTRACT	6
ABSTRAK	7
TABLES OF CONTENT	8 - 9
TOPIC 1: INTRODUCTION	10 - 13
1.1 Introduction	
1.2 Project Background	
1.3 Problem Statement	
1.4 Project Objective	
1.5 Research Questions	
1.6 Project Scope	
1.7 The Importance of The Project	
1.8 Operation Definition	
1.9 Project Result	
1.10 Summary	
TOPIC 2: FIELD RESEARCH	14 - 17
2.1 Introduction	
2.2 Previous Research/Review/Investigation/Literature Review	
2.3 Summary	
TOPIC 3: METHODOLOGY/PROJECT SHAPING	18 - 30
3.1 Introduction	
3.2 Project Assembly/Design Process	
3.2.1 Project Sketching	
3.2.2 Project Discussion	
3.2.2 Materials and Equipment	
3.2.3 Method/Procedure/Project Creation Techniques	
3.3 Summary	
TOPIC 4: RESULTS AND DISCUSSION	30 – 35
4.1 Introduction	
4.2 Data Analysis	
4.2.1 Method of Analysis Data	
4.3 Discussion	
4.4 Summary	

TOPIC 5: CONCLUSION AND RECOMMENDATION	36 - 38
5.1 Introduction	
5.2 Conclusion	
5.3 Recommendation	
5.4 Limitation Project	
5.5 Summary	
REFERENCE	39
APPENDIX	40 - 52
i. Cost Estimation Project	
ii. Specification and List of Materials and Equipment	
iii. Gantt Chart	
iv. Sketching/Drawing/Circuit Diagram/Flowchart	

TOPIC 1: INTRODUCTION

1.1 INTRODUCTION

Turn signals are found in all types of vehicles. One of the problems that we often see is that when a motorcyclist turns on their turn signal, they often forget to turn it off after a turn and this can not only confuse other people on the road but also can cause accidents to occur. As the name implies, a turn signal functions to give a sign or signal to the driver behind or in front of him that the motorcycle is about to turn. If the left turn signal is turned on, the vehicle will turn left. On the other hand, if the turn signal light is turned on to the right, the motorcycle will turn right. On a motor, there are usually several turn signal lights, on the front there are 2 pieces (left and right), on the back there are also 2 pieces.

For methodology research, we use a prototype of a turn-off signal alarm system with a replicate of the handle. A survey has been done to identify the problems with the existing turn signal and things that need to be upgraded. We analysed the survey and determined the important parts that need to be upgraded on a turn signal.

1.3 PROJECT BACKGROUND

At the start of the 1900s, automobile drivers signalled to other drivers and pedestrians their intention to turn (or stop) their vehicles with their hands. There were no turn signals these days. The hand signals for right and left turns and stop/slow have not changed since that time. Just watch a bicyclist and you will see these in action.

The first modern electric turn signal can be credited to Edgar A. Walz, Jr. who in 1925 obtained a patent for one and tried to market it to the big car manufacturers. Believe it or not, the car manufacturers just weren't interested, and the patent expired 14 years later with no buyers.

Interestingly, the turn signal situation in Europe began differently. The answer to the problem of needing to signal turns or lane changes was originally done by hand signals but later through via "semaphore indicators". The indicator's mechanical arms known as Trafficators mounted on the cars' sides. These Trafficators were powered by electro-magnets that raise one arm with a bright light (almost always mounted high on the door pillar) indicating a turn was about to be made.

Back in the States, Buick was the first United States automaker to offer factory-installed flashing turn signals. Introduced in the late 1930s as a safety feature, turn signals were advertised as the “Flash-Way Directional Signal”. The flashing signals worked only on the rear lights. In 1940 Buick changed around the directional indicators by extending the signals to front lights, and then adding a self-cancelling mechanism. That year (1940) directional signals became standard on Buick, Cadillac, Hudson and LaSalle vehicles and available (for a cost of \$7.95) on Chevrolet, Oldsmobile, and Pontiac.

For those vehicles without them, the Illinois-based Lester Company offered a Simplex Direction Signal Kit for '42 to '49 models, advertising that these signals, which could be purchased for \$8.95, would work “like factory-installed models on expensive cars”.

In 1968 the Federal Motor Vehicle Safety Standard 108 required amber lens front turn signals; rear signals could be either red or amber. Note: It was also in the 60s that 4-way hazard flashers were first required on manufactured vehicles.

Reliable light-emitting diode (LED) technology for signal lights came about in the 1980s. Because such lights didn't depend on lens colour, they emit true amber and red hues, clear lenses could be used. While it has not happened yet, it may not be long before filament bulbs have been 100% phased out.

Although the basic turn signal technology has not changed in years, future improvements could include increased strength and durability for parts that are always being used and abused, an alert when the turn signal switches off even before we have started our turn and turn-signal tones that we can personalize. While there is still a need for such innovations, we are all better off relying on technological wizardry rather than hand signals. We hope that you have enjoyed learning about how modern-day turn signals came to be! Thank you to the Service team at DCH, a Chrysler dealership in Temecula, CA, for their assistance with this article!

1.3 PROBLEM STATEMENT

When motorcyclists turn on their turn signal, they often forget to turn it off after a turn and this can not only confuse other people on the road but also can cause accidents to occur.

1.4 OBJECTIVE

The objective of this project is:

- To create a turn off signal alert system that uses vibration to notify motorists to turn off their turn signal.
- To reduce accidents that involve motorcyclists forgetting to turn off their signal occur.

1.5 RESEARCH QUESTIONS

This study will answer the following research questions:

- Does motorcyclists forgetting to turn off their turn signal confuse other people?
- Can a turn signal alert system help notify motorcyclists to turn off their turn signal?
- Is it possible to create a turn signal alert system?

1.6 SCOPE OF PROJECT

- This system only can be used for motorcycles (150 cc to 250 cc) only.
- The signal notifier will not switch off even if the handle is turned until its limit.
- This Turn Off Signal Alert System is not waterproof.
- The vibrator for this system only can be put on the left handle of the motorcycle.

1.7 IMPORTANCE OF THE PROJECT

- To notify the motorcyclist about the turn signal is still turned on.
- To reduce an accident, occur.
- To reduce the other road user confused with the motorcyclist direction.

1.8 OPERATION DEFINITION

- **Motorcycle handlebar:** It is a component of a motorcycle's steering mechanism. Handlebars provide a mounting place for controls such as brake, throttle, clutch, horn, light switches, and rear-view mirrors.
- **Coin vibrator:** It is also called a pancake vibrator motor. It is a compact size coreless DC motor used to inform the users of receiving the signal by vibrating, with no sound. Vibration motors are widely used in a variety of applications including cell phones, handsets, and pagers.

1.9 PROJECT RESULT

- By the end of this project, we should have a finished turn signal alert system that works well and can notify motorists using vibration. The project should be able to solve problems such as motorists forgetting to turn off their turn signal which can confuse other road users thinking that motorists will be turning or might pull out in front of them risking an accident to occur.

1.10 SUMMARY

- In this chapter, the studies were explained about the origin of ideas and inspirations. All the objectives were made from all the problem statements. The objective for this project along with the importance that will be cheap and light causing it to be more convenient for and even the scope of this project only. Thus, this new product could be used for daily routine with really good care for a longer lifetime.

TOPIC 2: LITERATURE REVIEW

2.1 INTRODUCTION

While seemingly obvious, an easy way to avoid accidents on the road is by using turn signals. Avoid accidents by Using your Turn Signals explained by TJ Woods Insurance Agency in Worcester MATurn signals are vital to obey the “rules of the road”. Many accidents could easily be evaded if turn signals were used more often. Drivers underestimate the power of turn signals. They are essential for letting drivers know the direction a car wants to go. A turn signal allows others to determine what they should be doing with their car, in relation to the other cars on the road. Turn signals are the only predictor of where a car wants to go.

Whether it’s turning into a parking lot, switching lanes on the highway, or pulling out of a side street, when a driver uses their turn signal, they are allowing others to know their desired path. Using turn signals is especially crucial in order to avoid accidents on the highway since cars are moving at a fast velocity and could cause serious accidents if they neglect to use their turn signals.

Our project is invented to solve the problem when motorcyclists turn on their turn signal, they often forget to turn it off after a turn and this can not only confuse other people on the road but also can cause accidents to occur.

2.2 PROJECT RESEARCH/LITERATURE REVIEW/RESEARCH ON THE MARKET

Road crashes are serious concerns globally as they claim and cause more than 1.35 million fatalities and up to 50 million resulting injuries each year, respectively. Previous studies showed that the causes of road crashes are multifactorial, with human error contributing to approximately more than two-thirds of all road crashes, particularly in developing countries. One of the primary causes of vehicle crashes is the failure to use turn signals by motorists. Although several studies have explored the use of turn signals among motorists in developed countries, limited studies have examined such risky behaviour in developing countries, especially Malaysia. This paper aims to investigate the prevalence and characteristics of turn signal use among motorcyclists especially when changing lanes and turning at intersections, in Klang Valley, Malaysia. Video data of motorcycles in road traffic were recorded via

instrumented research vehicle which made routine trips along selected driving routes in Klang Valley. The driving routes encompassed expressways, mixed with urban and interurban roads, as well as rural roads. The results reveal a significantly low overall percentage usage rate of turn signals among the observed motorcyclists at 41.1%. Furthermore, 60.9% of motorcyclists failed to signal when changing lanes, and 56.5% disregarded them while turning at intersections. The findings provide vital information to the authority to develop proper policy and propose measures to increase compliance with turn signal use among motorcycle motorcyclists such as more targeted enforcement, widespread road safety campaigns and mandated utilization of technology-based solutions.

Author: *Aqbal Hafeez Ariffin*

Traffic accidents and fatalities are major concerns in many countries around the world, particularly in developing countries where the transport system is dominated by motorcycles. Causes of vehicle crashes are multifactorial and involve the interaction of several pre-crash factors that include people the and environment. A total of 17,142 objects were observed, including 2,392 car drivers and 14,750 motorcyclists. The overall prevalence of turn signal use among observed drivers and riders was around 90%.

Author: *Nguyen-Phuoc, Tran, De Gruyter, Kim, Su*

A typical claim of vehicle drivers involved in accidents is that they have seen the motorcyclist they were about to overtake or cross but did not understand that the motorcycle was going to turn because the turn signal was on.

Author: *Hurt, Hugh H.; Ouellet, J. V.; Thom, David R.*

From our research, we found out that forgetting to switch off the turn signal is one of those things that happens to nearly everyone, especially to motorists and the danger cannot be underestimated. Other road users, thinking that a motorist will be turning, might pull out in front of you and this can increase the risk of accidents to happen. To solve this issue, we have come up with a project called a turn signal alert system. This turn signal alert system uses a vibrator to notify the motorist that their turn signal light is still on, and the vibrator will continue to vibrate till the motorist decides to turn off their turn signal. The vibrator is attached to the turn signal switch which is located on the handle of the motorcycle.

From our research, we also found out that there is already a solution to this problem which is a smart turn signal system or also known as a self-cancelling turn signal system. This system uses a small electronic device that cancels your turn signal automatically after each turn, lane change or roundabout exit. However, this smart turn signal system has received a lot of bad reviews from users that have tried it out.

Some stated that the system is hard to install, the system does not cancel the signal after certain turns and many more.

2.2.1 EXISTING TECHNOLOGY



" STS - Smart turn system - Self cancelling"

The Smart Turn System or STS is a relatively new product from a Slovenian start-up company, ABCS SISTEM Ltd. The development team of electrical and mechanical engineers are also riding enthusiasts with a penchant for staying safe and their assessment, analysis and R&D led to the development of the STS. The STS is basically a “black box” containing a microprocessor and system that is plumbed or spliced into the motorcycle’s turn signal wiring.

It measures acceleration, inclination, heading and vibration — up to 300 different data elements per second, according to the company. The measurements determine what the motorcycle is doing under rider control so as to provide the appropriate system output response at the right time. The STS detects, recognizes and differentiates between left and right turns, lane changes, roundabout (traffic circle) movements and over-taking.

Its functionality is simple; with the turn signal activated by the rider, once the manoeuvre (lane change, turn, traffic circle or whatever) is completed the STS cancels the turn signal automatically. Some very quick or slight manoeuvres may not be detected, in which case the STS may not immediately cancel an activated turn signal. But the STS has a fail-safe mode that will turn off the activated turn signal after 14

seconds of movement unless cancelled earlier by the rider. The simple boxed package contains the STS unit, five connectors, zip ties and small foam pieces (used for the mechanical version) and an installation manual.

In addition to the printed instructions, all version instructions in short and long form, as well as additional information, is available online with some interesting background and research facts. The Smart Turn System (STS) device and its methods are patented, and the product is certified for road use and carries FCC, e26, CE and German TUV compliance certifications.

REVIEW ABOUT SMART TURN SYSTEM (STS) – SELF CANCELLING:

Dan N Tuesday, 15 January 2019

"I tried this device for 3 months and 6000 miles and then removed it. 1) I found it unpredictable for lane changes into turn lanes; Sometimes it would turn off and other times it would not. I would have to check it, taking my eyes off the road. 2) I often put on my turn signal early; I would find myself at an intersection with the blinker off. 3) If you have more than one moto you need it on all of them; habits". methods were discussed and research was done, these objects have their own benefits from many perspectives. After conducting a study on the materials and components needed to build this project, it was found that components with appropriate specifications should be used to prevent accidental accidents.

John Thursday, 04 August 2022, Gord Matsalla wrote:

" I received this item and tried hooking it up to my Honda but it doesn't work. I have tried now for a week to email for help but there has been zero support. I would like to make it work but I can't get any help from these guys. I am looking for a phone number because they don't answer any emails".

2.3 SUMMARY

To finish this chapter, it is important to present all studies of materials and methods to improve the understanding of this project. Every thesis and other project relating to this electronic system allows us to understand it fully. Especially for us. After a lot of materials and methods were discussed and research was done, these objects have their own benefits from many perspectives. After conducting a study on the materials and components needed to build this project, it was found that components with appropriate specifications should be used to prevent accidental accidents.

TOPIC 3: METHODOLOGY

3.1 INTRODUCTION

Project methodology refers to the specific approach or set of principles, practices, and procedures used to guide the execution of a project from start to finish. It provides a structured framework for planning, organizing, and controlling project activities to achieve desired goals and deliverables. There are various project methodologies available, each with its own characteristics and recommended practices.

The concept design for turn off signal alert system was chosen based on the suitability, cost and research that has been done. The invention was made with the appropriate method, using the coin vibrator as the main component for this project. The activation of the vibrator has been conducted at the handle of the motorcycle so that it can help the riders to notice that the turn off signal did not turn off yet.

3.2 PROJECT ASSEMBLY/DESIGN PROCESS

3.2.1 PROJECT FLOW CHART

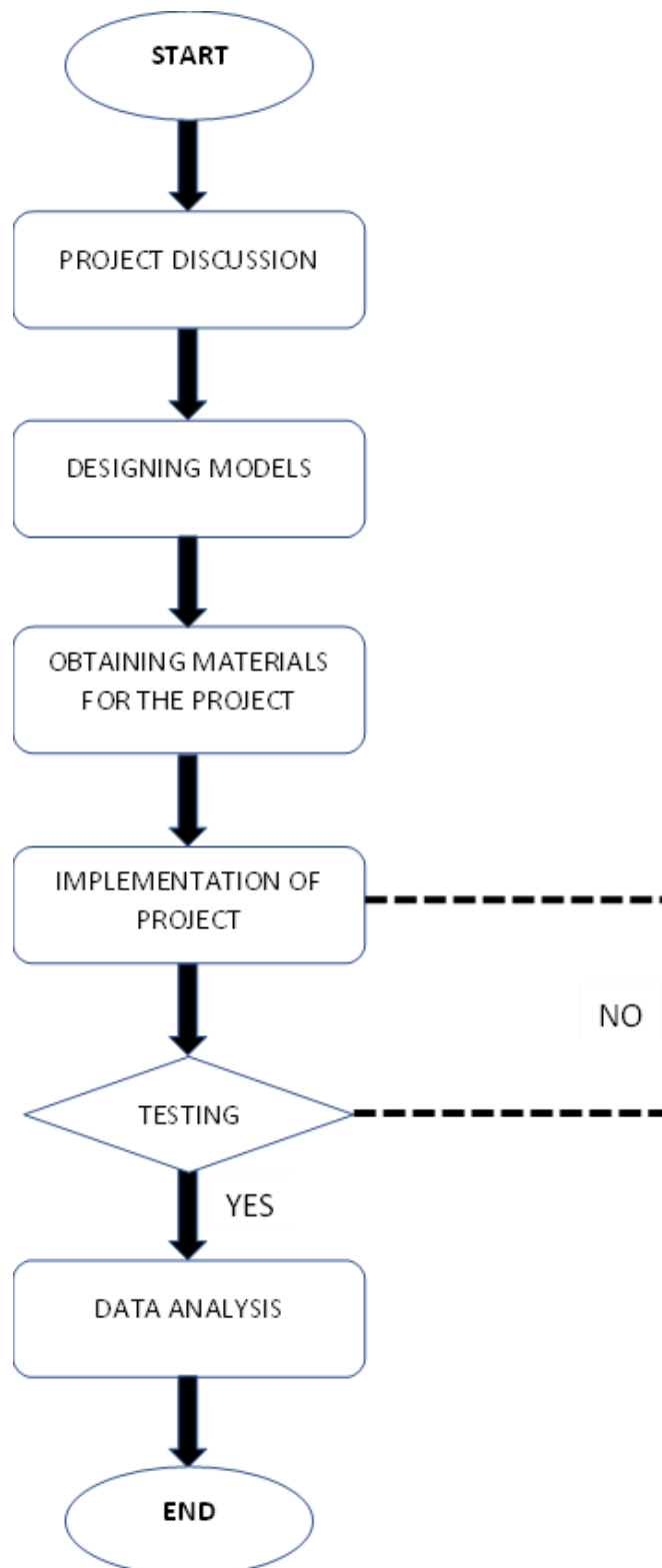

3.2.2 PROJECT DISCUSSION

i. Identification of issues, flaws, and limitations.

The process of recognizing and understanding the problems, imperfections, and constraints that exist within the project. It involves systematically examining and assessing various aspects of the project to identify areas that may pose challenges or hinder its success.

When conducting the identification of issues, flaws, and limitations of a project, the goal is to uncover potential obstacles, weaknesses, or shortcomings that may impact the project's objectives, timeline, budget, or overall quality. This process requires careful analysis, evaluation, and documentation to ensure a comprehensive understanding of the project's strengths and weaknesses.

From this process, it has been uncovered that the 1 vibrator was not strong enough to be felt on the signal switch, to solve this 2-coin vibrator is used instead of 1. A survey was also conducted to further investigate the issue. The result of the survey shows that most people think that motorcyclists often forget to turn off their turn signal and other road users often get confused by it. Most people also think a turn off signal is needed to help reduce this issue.

ii. Designing process

In the designing process, a few research has been done on the items/equipment that's going to be used and the sketching of the circuit to ensure the design is perfect and will have no issues. Instead of using a step-down power converter, a voltage regulator is decided to be a better fit for this project due to the size difference. To increase the strength of the vibration, two 5V coin vibrators are used instead of one. A butt connector is used to join all negative wires into one wire and to provide a quick and convenient way to connect wires together, saving time and effort. Crocodile clips are chosen to connect the circuit to the power supply. Spade connectors are chosen to be used to connect to the flasher relay and to the turn signal switch. Finally, a T-Tap connector is chosen to be used to provide a convenient and efficient way to tap into the flasher relay load wire.

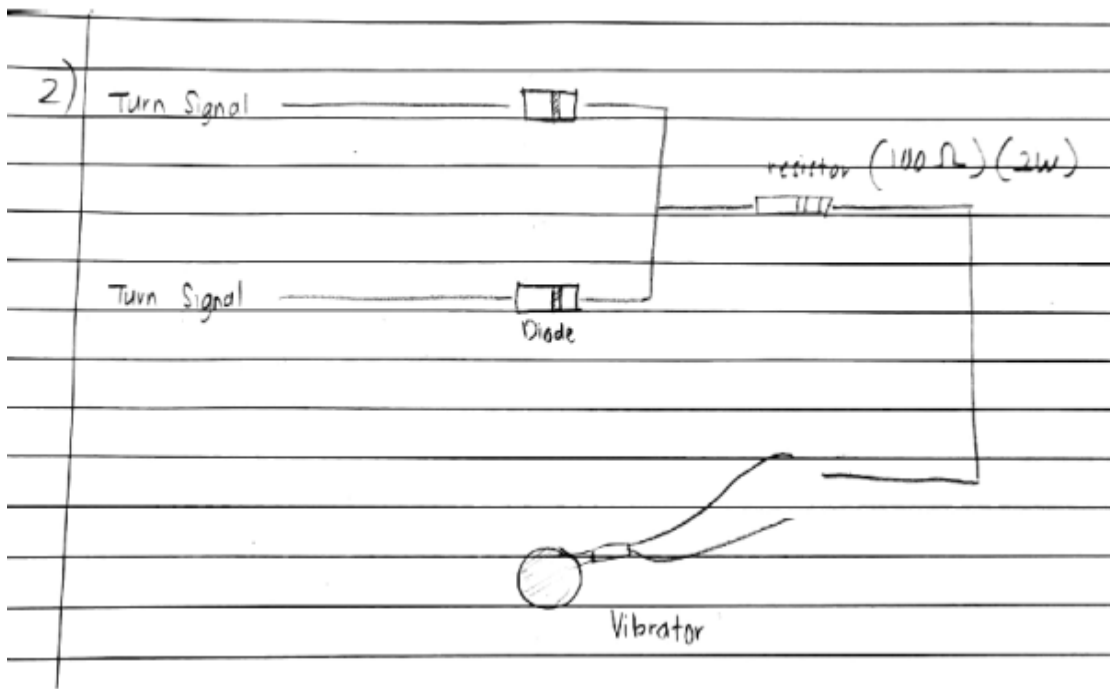

INITIAL CIRCUIT SKETCHING

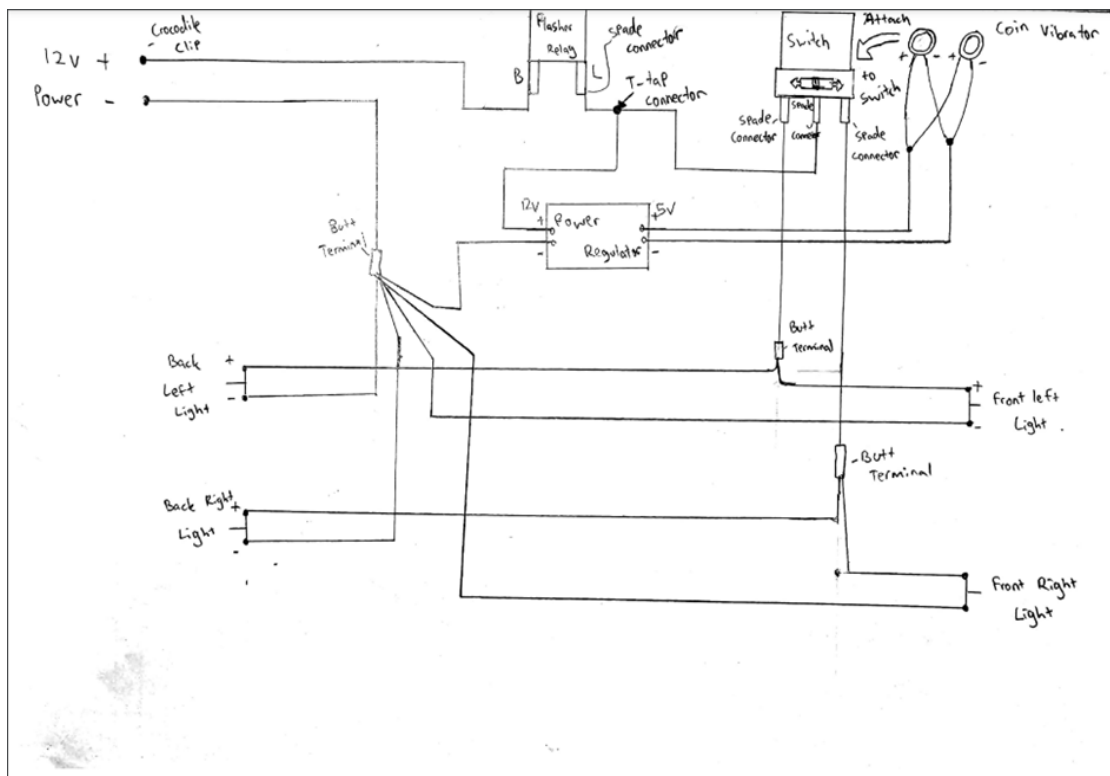

FINAL CIRCUIT SKETCHING

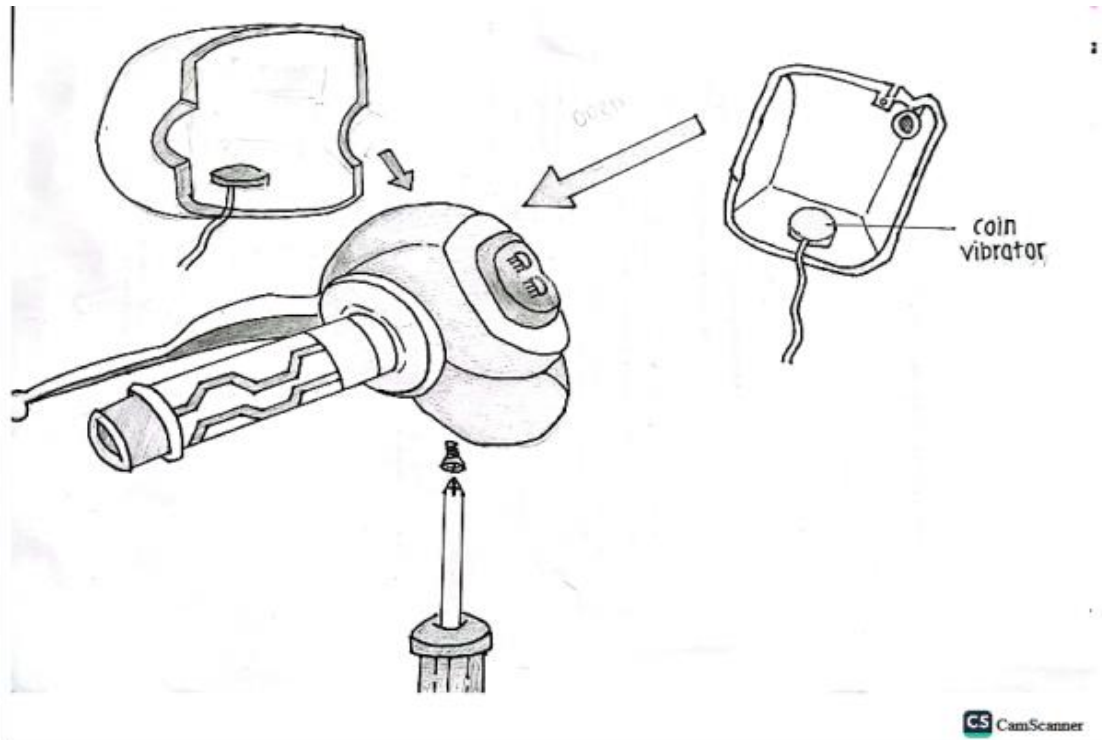

DESIGN SKETCHING

3.2.2 MATERIALS AND EQUIPMENT

Obtaining materials and equipment for a project involves a series of steps to ensure that the required resources are procured efficiently and effectively. Before obtaining all materials and equipment, research and all requirements are identified for the project. A wooden board from a cupboard is used as the base of the project and painted silver for aesthetic purposes. An L-shaped stand and a U-Shaped hook are used as a stand for the motorcycle handle. All materials and equipment are bought online on Lazada and Shopee, at MR.DIY and at Pudu, Kuala Lumpur. All Materials and Equipment needed/used for this project are:

1. Drill - To drill holes in the wooden board and in the stands.
2. Wire Crimping Tool - To create secure and reliable electrical connections by crimping or compressing metal connectors onto the ends of wires.
3. Wire Connectors/Terminals - To join or terminate wires securely and reliably. The connectors used are spade connectors, T-Tap connectors, and butt connectors.
4. Wire Cutter - To cleanly and accurately cut through wires, such as electrical wires, cables, and conductive materials. Also used to remove the insulation or outer covering from electrical wires safely and precisely.
5. Crocodile Clip – To connect the circuit to the power supply.
6. 18 AWG Wires – Wire typically used in motorcycle turn signal circuits.
7. Coin Vibrator – One of the main components in the project, used to notify riders to turn off their turn signal light.
8. Motorcycle Handle – Actual motorcycle handlebar
9. Motorcycle Turn Signal Lights - Actual motorcycle turn signal lights.
10. Wooden Board - Used as the base of our project to build the circuit on
11. Zip Tie – To tie down all the wires to the board and wires together, making the circuit look neat and tidy.
12. Motorcycle Turn Signal Switch – Actual motorcycle turn signal switch.
13. Solder – To attach wires together and extend the length of the coin vibrator wire.
14. Soldering iron – To melt solder.
15. Spray paints – Black and silver spray paint is used to spray the wooden board and stand for aesthetic purposes.
16. Cable sleeve – Used for cable organisation.



Buying project equipment/materials at Pudu, Kuala Lumpur



Buying project equipment/materials at MR.DIY

3.2.3 METHOD/PROCEDURE/PROJECT ASSEMBLY METHOD

1. Spraying process – Wooden board is painted silver and the stands are painted black using spray paints bought from MR.DIY. Once done spray painting the wooden board and stands are left to dry.

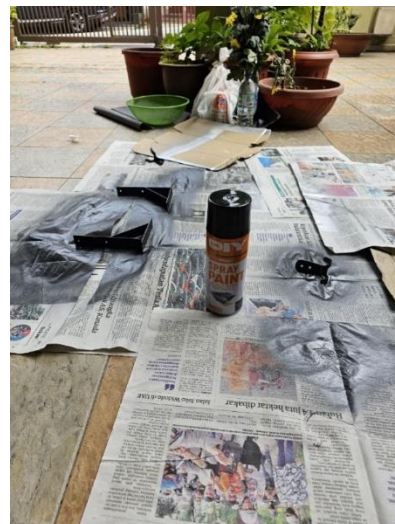

2. Wire cutting and trimming process – All wires are cut according to suitable lengths and the wire insulation or outer covering is removed using a wire cutter.



3. Soldering process – Coin vibrators extended using solder and covered using wire tape once done.



4. Wire crimping process – Spade connectors, crocodile clip and butt connectors are crimped at the end of wires using a wire crimping tool. Before wires are crimped, wires are twisted together first.

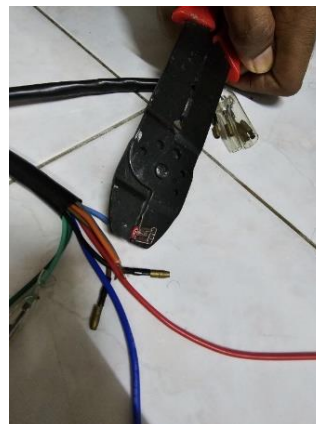
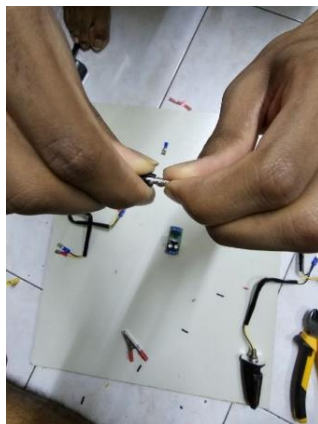

5. Connecting process – Once finished crimping wires, all spade male spade connectors are connected to female spade connectors and the coin vibrator wire is connected to the voltage regulator. Certain connectors are then tapped with wire tape to avoid them from touching each other which can affect the operation of the circuit.

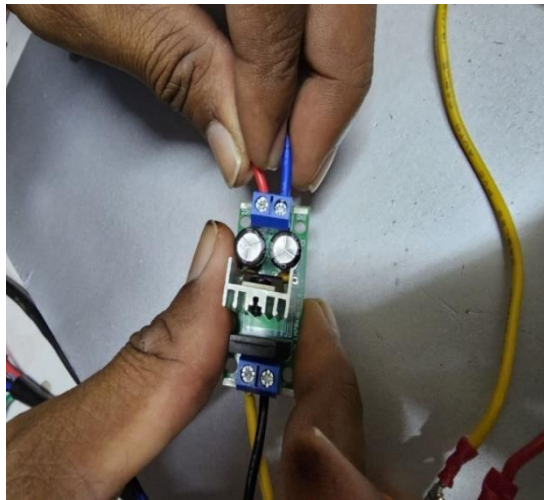
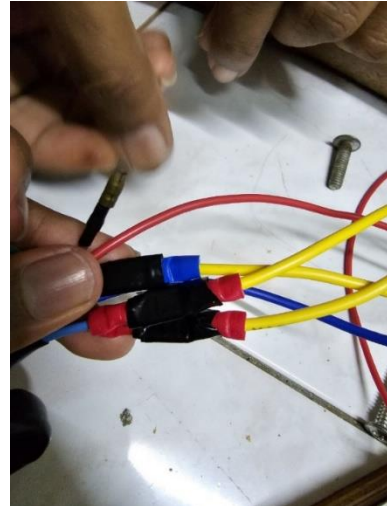
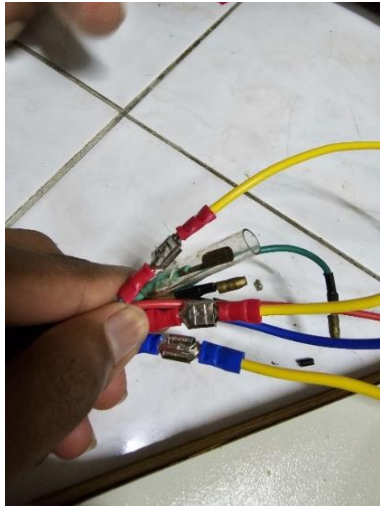

6. Wiretapping process – Once done connecting the wires, the positive wire from the voltage regular is tapped into the flasher relays load wire using a T-Tap connector and the negative wire of the voltage regulator is compiled together with the rest of the negative wires in the circuit.



7. Drilling and screwing process – Holes are drilled in the wooden board using an electronic drill so that wires can be zip tied to the board. The stands are also drilled to increase to the size of the hole to be screwed.

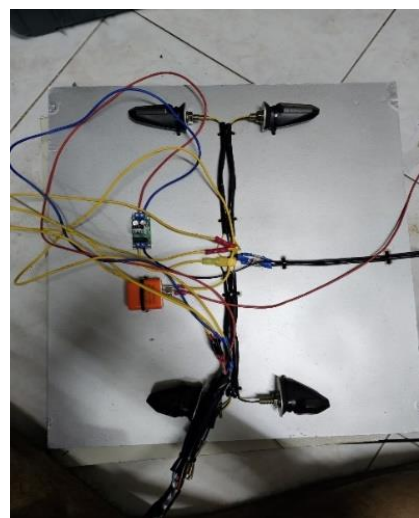
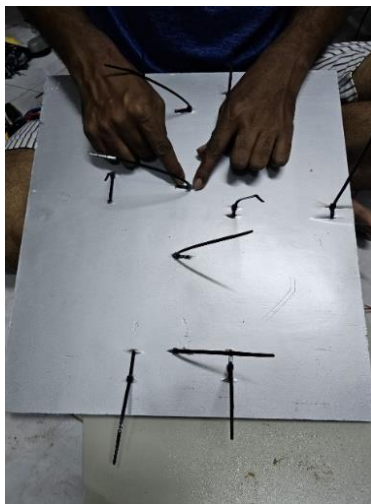

8. Minor testing test – Before the final assembly, the circuit is tested to see if everything is working.



9. Sleeving and final assembly process – All wires from the turn signal switch are covered using a cable sleeve to make the circuit look tidy and the stands are attached to the wooden board. Once done all components are labelled.



PROJECT WORKING PROCEDURE

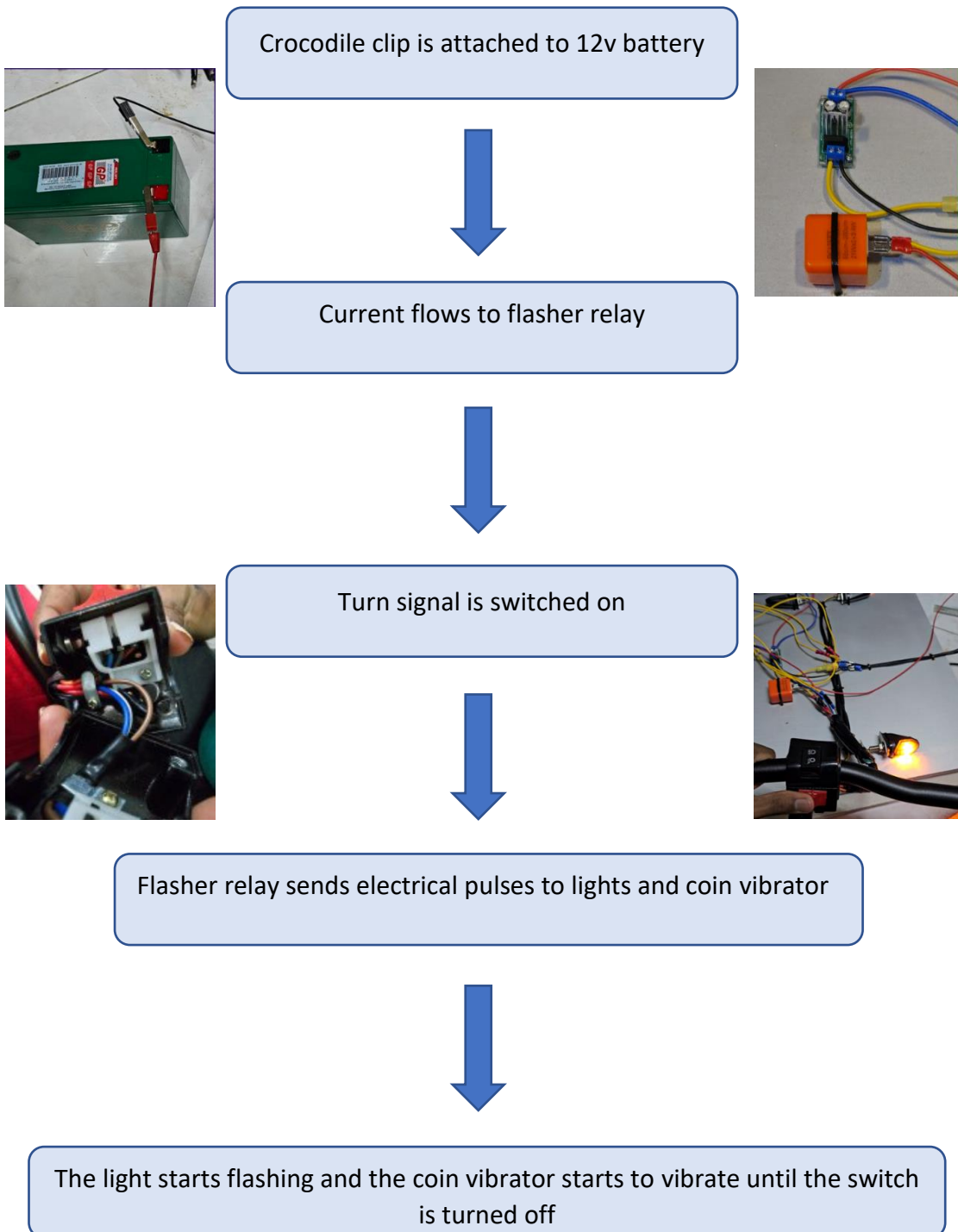

3.3 SUMMARY

In the first stage, the methodological study creates a systematic research design, data collecting methods, study instruments, data sampling techniques, and data analysis methods to learn the facts information needed to support the study instrument and explain the study more clearly. After the data has been analysed, it is necessary to write a summary or draw a conclusion about the findings and hypotheses, such as whether the turn off signal alert system is useful or not.

TOPIC 4: RESULTS AND DISCUSSION

4.1 Introduction

The results and discussion of a project report is a crucial component that presents the outcomes and analysis of the project. This section allows for a comprehensive examination of the project's objectives, methodologies employed, and the resulting findings. It provides an opportunity to discuss the significance of the project and its potential impact in the relevant field or industry.

In this section the results obtained from our project, which aimed to address issue of motorcyclist forgetting to turn off their turn signal will be discussed and presented. This project focused on creating a turn off signal alert system that uses vibration to notify motorist to turn off their turn signal. By undertaking this project, we sought to reduce accidents that involves motorcyclist forgetting to turn off their signal occur and reduce the number of motorcyclists forgetting to turn off their turn signal.

4.2 Data Analysis

4.2.1 METHOD OF ANALYSIS DATA

i. QUESTIONNAIRE (Before Project)

A) CAR

Do you feel like accidents often happen due to riders forgetting to turn off their turn signal? Adakah anda merasakan kemalangan serin... terlupa untuk mematikan lampu isyarat mereka?

25 responses

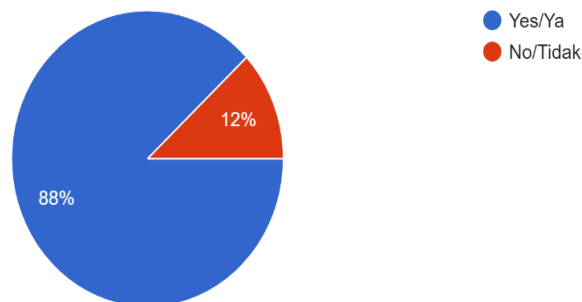

Do you often run into riders that forgot to turn off their turn signal? Adakah anda sering terserempak dengan penunggang motosikal yang terlupa mematikan lampu isyarat mereka?

25 responses

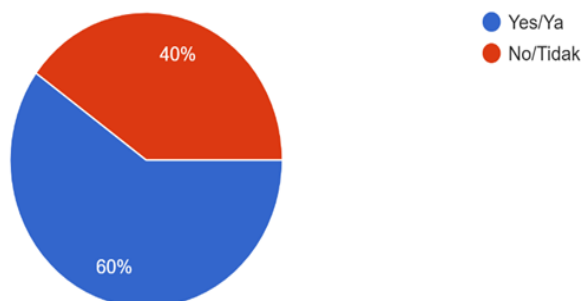

Do you think that riders forgetting to turn off their turn signal can cause accident to occur? Adakah anda fikir penunggang motosikal terlupa untuk ...u isyarat boleh menyebabkan kemalangan berlaku?

25 responses

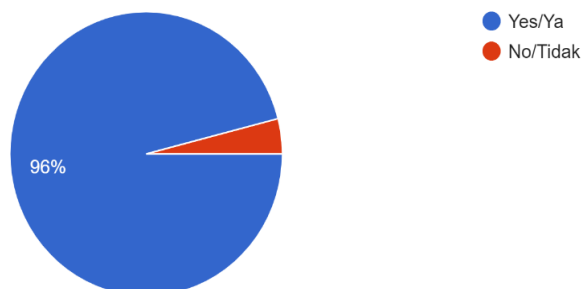

Do you think a turn off signal system that can help to notify riders that their turn signal light is still on will be helpful? Adakah anda fikir sistem lampu isyarat mereka masih menyala akan membantu?
25 responses

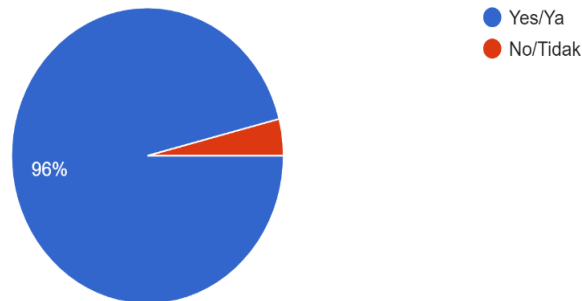

B) MOTORCYCLE

Do you often forget to turn off your turn signal light? Adakah anda sering terlupa untuk menutup lampu isyarat motorsikal anda?
12 responses

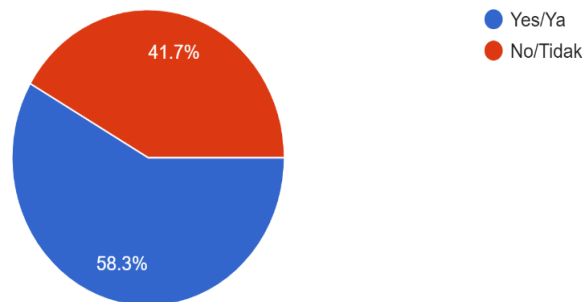

Do you think that riders forgetting to turn off their turn signal can cause accident to occur? Adakah anda fikir penunggang motorsikal terlupa untuk ...u isyarat boleh menyebabkan kemalangan berlaku?
12 responses

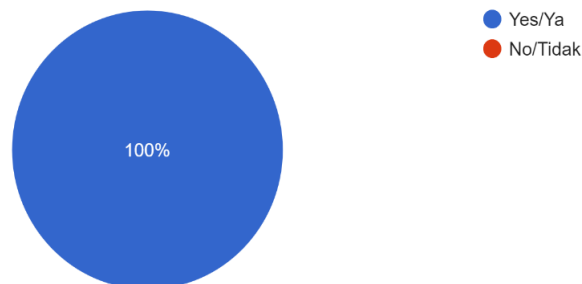

Do you think a turn off signal system that can help to notify you that your turn signal light is still on will be helpful? Adakah anda rasa sistem matika...syarat belok anda masih menyala akan membantu?
12 responses

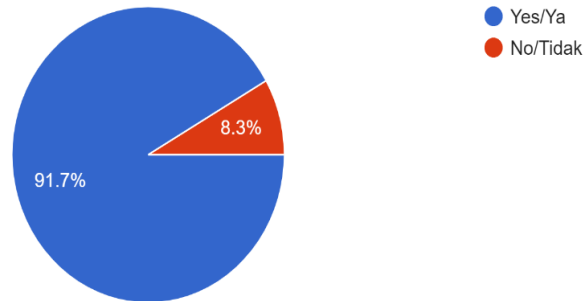

Do you think other drivers often get confused running into riders that forget to turn off their turn signal? Adakah anda rasa pemandu lain sering ke...ng terlupa untuk mematikan isyarat belok mereka?
12 responses

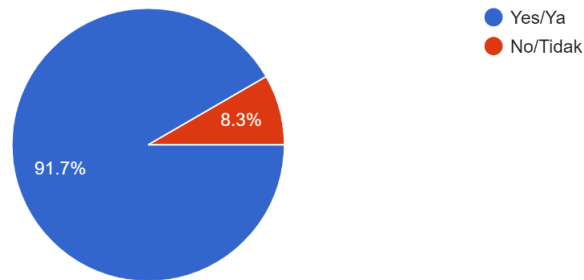

ii. QUESTIONNAIRE (After Project)

Do you think this system can help notify the riders to turn off their turn signal? Adakah anda berpendapat sistem ini dapat membantu mempering...ikal untuk mematikan isyarat pusingan mereka?
30 responses

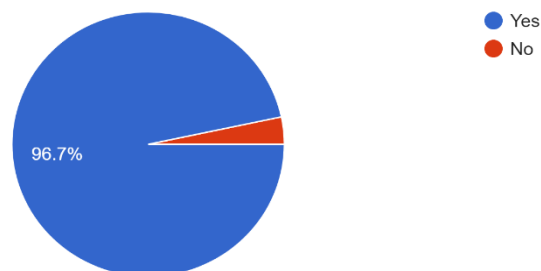

Do you think the vibration of the vibrator is strong enough for the riders to feel/notice it? Adakah anda berpendapat bahawa getaran pada penggeta...ara pemandu untuk merasakannya/mengenalinya?
30 responses

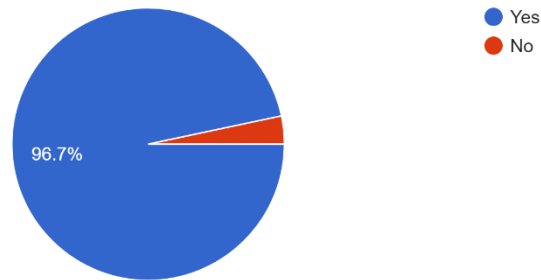

Do you think this system can help reduce the rate of motorcycle rider-related accidents on the road? Adakah anda berpendapat bahawa sistem in...ya yang disebabkan oleh penunggang motosikal?
30 responses

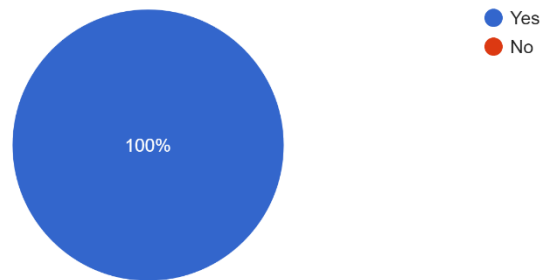

iii. Vibration reliability test

Left vibrator running for several hours to check if vibrator is still working and is reliable.

Time (Hr)	STATUS
1	Still Working
2	Still Working
3	Still Working

4.3 DISCUSSION

After the assessment process and respondent feedback, our final product Turn Off Signal Alert System has finally been fabricated with two coin vibrators in turn signal switch. This system is aimed to help motorcycle users be notified by using vibration to turn off their turn signal switch after making a turn or changing lanes. When a motorcyclist makes a successful turn or changes lane, they often forget to turn off back their turn signal switch. This will lead to some confusion for other road users. Furthermore, an accident can occur involving motorcyclists that forget to turn off their signal. Based on the literature review that has been made in Chapter 2, a few research have been conducted for this project. First and foremost, the research of the method of identifying awareness of motorcyclists to turn off their signal in daily life then is the smart turn system – self-cancelling that is available on the market. Testing also has been done to identify whether a single coin vibrator is suitable to use in this project. We have successfully achieved the objective of this project as stated in Chapter 1.

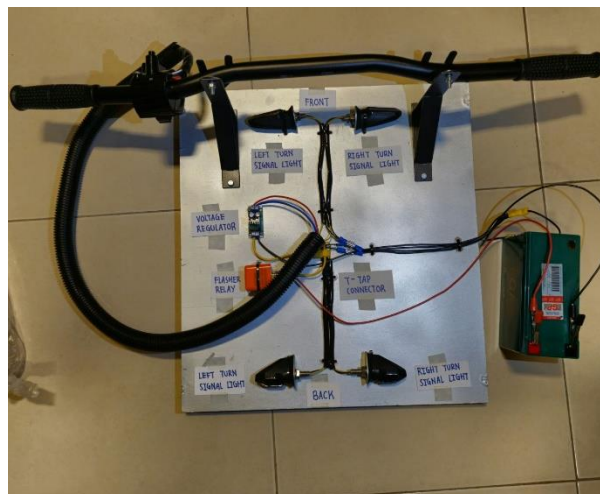

4.5 Summary of Chapter

To summarise this chapter, a lot of questionnaires have been made to get the result about the effectiveness of our project to other people. After making these questionnaires, there are a lot of data that we have collected to make some analysis about our project. So, the result is the majority of respondents agreed that Turn Off Signal Alert System can help notify motorcyclists to turn off their turn signal. Lastly, the majority also agreed that our project can help reduce the rate of motorcycle rider related accidents on the road.

TOPIC 5: CONCLUSION

5.1 Introduction

The conclusion and discussion of the turn signal alert system are to make the consideration of the potential risks and benefits involved which to reduce the potential of accidents occurring because the turn signal is not off. Thus, in this chapter there will be explain about the recommendation, reliability effectiveness, and impact on daily operations need to be thoroughly evaluated.

5.2 Conclusion

The turn off signal alert system can help notify motorists when they are not turning off their turn signal. Careful consideration should be given to its impact, effectiveness, and the potential reduction in accidents. The vibration of the vibrator plays a vital role in providing the vibration as a warning to the riders.

The function of the turn signal alert system is to reduce the potential of accidents that occur because of the negligence of the rider that forgot to turn off their turn signal. Studies have shown that these systems, including the vibration of the vibrator notification, can significantly contribute to reducing the occurrence of accidents and saving lives.

Road users' reliance on the vibration feature should also be considered. Drivers who are accustomed to receiving vibration alerts may develop a dependency on this sensory cue to make informed decisions and react promptly. The focus of this innovative system is to help people to reduce the confusion, hesitation or potentially risky behaviour of the rider that did not turn off their turn signal to other road users.

In conclusion, the vibration feature in the turn off signal alert system has a tangible impact on road users and plays a crucial role in its effectiveness in reducing accidents. The practicality of this innovation shows that this system may help people reduce the rate of accidents but it not fully hundred per cent can avoid the accident but only increases the rate of possibility of the riders turning off their turn signal.

5.3 Recommendation for improvement

The current feature of this project is still not fully mature and user-friendly. Improvement that can be made is by adding a wireless buzzer that could attach to the helmet of the rider to increase the effectiveness of this system. Besides that, this system also can be improved by adding a way to control the vibrator's vibration speed by using Arduino hardware. This improvement will give more flexibility and control to the riders in setting their vibration speed according to their convenience. For example, riders that wear some gloves can increase the vibrator's vibration speed by setting it. So, the vibration can be felt and notify the riders to turn off their turn signal.

5.4 Project limitation

This project has a few limitations, and this also considers the scope of this innovation.

The limitation is stated below:

- This system only can be used for motorcycles (150 cc to 250 cc) only.
- The signal notifier will not switch off even if the handle is turned until it's limit.
- The vibrator for this system only can be put on the left handle of the motorcycle.

5.5 Product Originality

Turn Off Signal Alert System is registered under the Intellectual Property Corporation of Malaysia MyIPO with a serial number LY2023W01179. As the diagram below shows the documents of MyIPO.

The image shows a scan of a MyIPO Copyright Act 1987 notification form. The form is titled 'NOTIFICATION OF COPYRIGHT IN A WORK' and includes the MyIPO logo. The application number is LY2023W01179. The title of the work is 'TURN OFF SIGNAL ALERT SYSTEM'. The language is English. The form is marked as 'COPY' and 'GR-1'. The date of creation/fixation is 10/03/2023. The work is unpublished. The author is listed as 'REFER ATTACHMENT'. There is a circular stamp from the Intellectual Property Corporation of Malaysia dated 28/03/2023.

MYIPO Application number

5.6 Impact on the communities

This project has several impacts that focus on the community. Firstly, this innovation can help motorcycle users to increase their awareness about turning off their turn signals by using a simple but practical method. Furthermore, this project also can help reduce accidents that involve motorcyclists forgetting to turn off their signal occur. So, it can decrease the possibility of road users experiencing off road crashes and injuries.

5.7 Summary

This chapter explains the project improvements that need to be done to make this project work better and effectively as well as the many advantages this system will do.

REFERENCE

- 1) H.B.C. (2017, April 8). *Smart Turn System Review, A Smart Turn Signal Cancelling System for Motorcycles*. Webbikeworld.com. Retrieved March 9, 2023, from <https://www.webbikeworld.com/smart-turn-system-review/>
- 2) Aqbal Hafeez Ariffin. (2020, September 2). *Turn Signal Use among Motorcyclists in Klang Valley, Malaysia: A Case Study*. Researchgate. Retrieved March 16, 2023, from https://www.researchgate.net/publication/344411472_Turn_Signal_Use_among_Motorcyclists_in_Klang_Valley_Malaysia_A_Case_Study
- 3) Barack. (2022, December 16). *Why Turn Signals Are Important For Motorcycle*. Royal-enfield.com. Retrieved April 6, 2023, from <https://www.royal-enfield.com/why-turn-signals-are-important-for-motorcycle-riders/>
- 4) Mark Leavitt. (2020, November 21). *Measuring Frequency of a Coin Vibrator Motor*. StackExchange. Retrieved April 13, 2023, from <https://electronics.stackexchange.com/questions/533394/measuring-frequency-of-a-coin-vibration-motor>
- 5) Shahrman Abu Bakar. (2020 January 10). *Initiatives to Increase the Use of Vehicle Turn Signals*. Researchgate. Retrieved May 4, 2023, from https://www.researchgate.net/publication/361866864_Initiatives_to_Increase_the_Use_of_Vehicle_Turn_Signals

APPENDIX

i. COST ESTIMATED PROJECT

Component	Unit	Cost Per Unit (RM)
Coin vibrator	2	3
Motorcycle handle	1	30
Battery	1	30
Wire Cable Connector Set	1	20
Voltage Regulator	1	12
Turn Signal Switch	1	35
Wires	4	3
Flasher Relay	1	4
Pair of Turn Signal Light	2	15
L-Stand	2	12
U-Bracket	2	4
Spray Paint (Black and Silver)	2	8
Wire Sleeve	1	5
		TOTAL
		RM 232.00

ii. SPECIFICATION AND LIST OF MAIN MATERIALS AND EQUIPMENT

a) Coin vibrator 3 - 5V



b) Motorcycle handle low bar 22mm



c) 12V 7AH Rechargeable Battery



d) Turn Signal Switch



e) Turn Signal Lights



f) 175PCS Assorted Crimp Spade Terminal Insulated Electrical Wire Cable Connector Kit Set Electric Wire Adaptor



g) Voltage Regulator Power Supply Module - LM7805

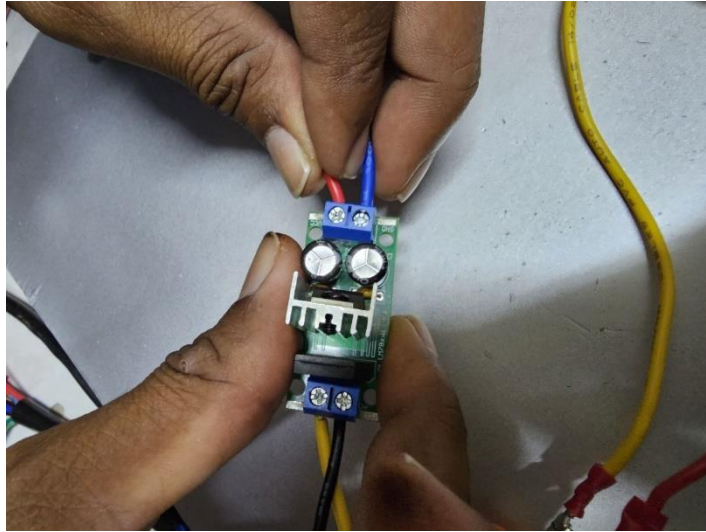

h) T-Tap Connector



iii. GANTT CHART (PROJECT 1)

12/1/22, 11:57 PM

Carta Gantt : Perancangan dan Pelaksanaan Projek Pelajar

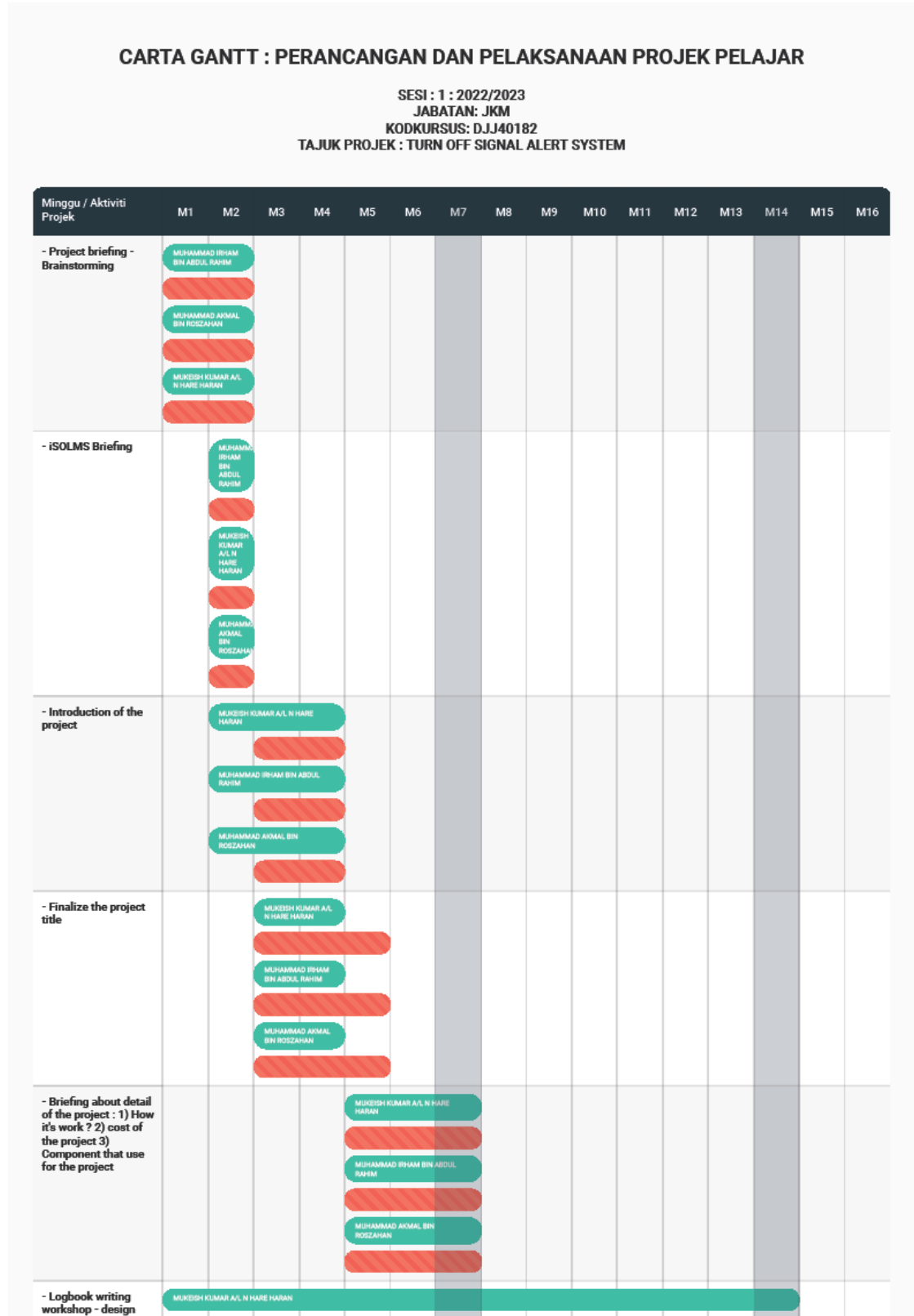

spmp.psa.edu.my/usolms/esolmsrancangprojekdetailumum.jsp?1dprojek=416

1/2

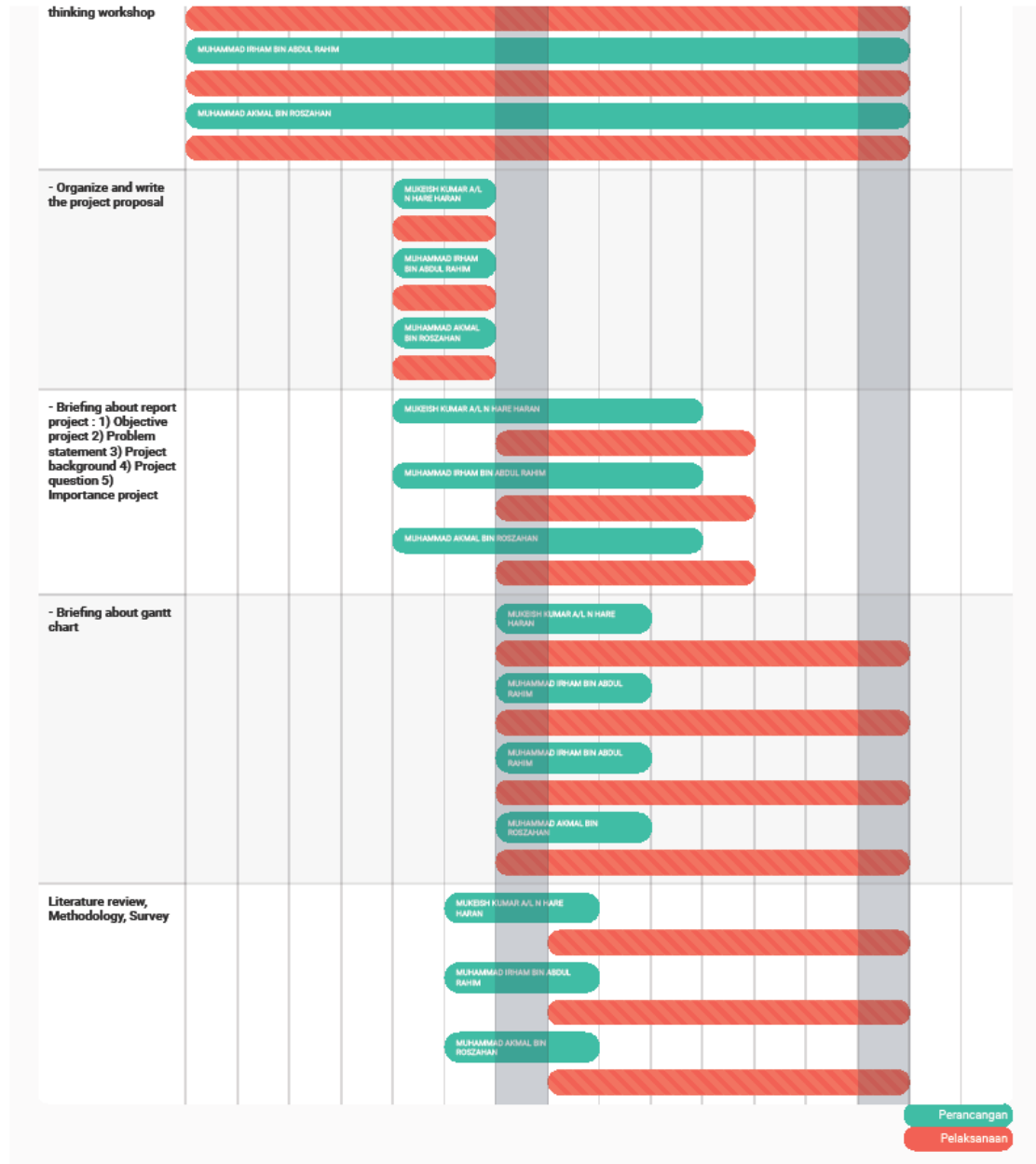

iv. GANTT CHART (PROJECT 2)

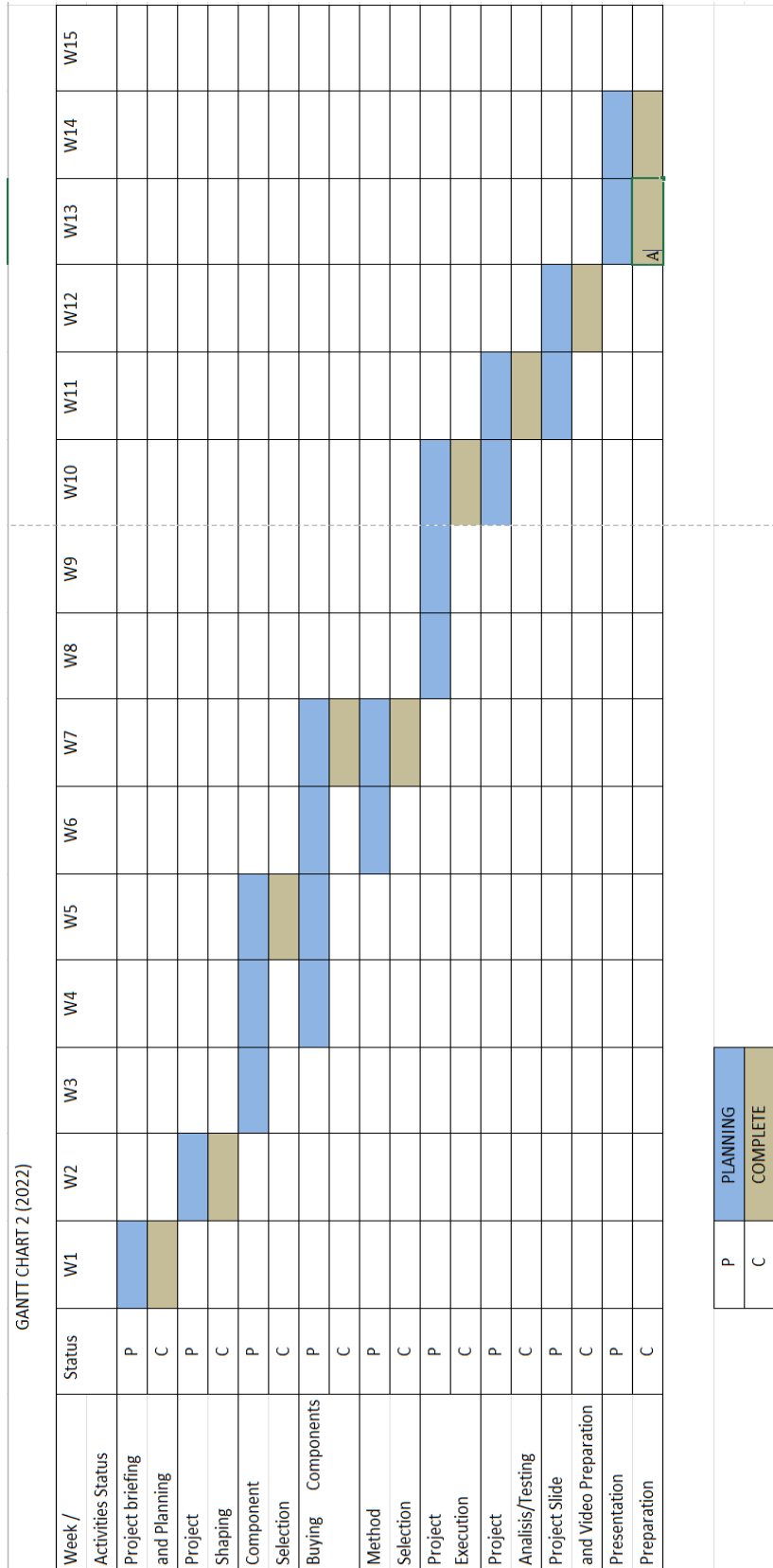

v. Project Application Letter



OPM VENTURE SDN. BHD. (Co. Reg. No. 976972-A)

12A-1 & 12A-2, Jalan PJU3/38, Sunway Damansara, 47810 Petaling Jaya, Selangor D. E. Malaysia.
Tel: +603-7733 6764 Fax: +603-7733 6765 Email: info@opmventure.com

No Rujukan : L-OPM-0523-002

Tarikh : 22.03.2023

En. Mohd Zulkarnaen Bin Mohd Ibrahim (Penyelia)
Mukeish Kumar A/L N Hare Haran
Muhammad Irham Bin Abdul Rahim
Muhammad Akmal Bin Roszahan

Tuan/Puan,

SURAT PENGESAHAN APLIKASI INOVASI- TURN OFF SIGNAL ALERT SYSTEM

Perkara di atas dengan hormatnya dirujuk.

2. Sukacita dimaklumkan kami telah mengaplikasikan produk inovasi **TURN OFF SIGNAL ALERT SYSTEM** daripada pihak tuan. Kami mendapati produk ini mampu mengurangkan masalah apabila penunggang motosikal menghidupkan lampu isyarat mereka, mereka sering lupa untuk mematikan lampu isyarat mereka setelah melakukan belokan atau memasuki simpang. Ini boleh menyebabkan kekeliruan kepada pengguna jalan lain dan juga boleh menyebabkan kemalangan berlaku.

3. Untuk itu bagi meningkatkan nilai komersial produk ini, pihak kami mencadangkan penambahbaikan yang boleh dibuat seperti berikut:

- i. Sistem perlu dikemaskini untuk mudah dipasang dan digunakan oleh semua pengguna.
- ii. Tambahkan kekuatan vibrator dan cara untuk mengawal kelajuan getaran vibrator menggunakan komponen seperti Arduino.

4. Semoga cadangan ini dapat memajukan lagi pembangunan produk tuan.

Sekian, terima kasih.

Yang benar,

(MARHADI MUSHAFFA)
Pengarah Urusan
OPM VENTURE SDN BHD



vi. Poster for Turn Off Signal Alert System



POLITEKNIK MALAYSIA
SULTAN SALAHUDDIN ABDUL AZIZ SHAH

TURN OFF SIGNAL ALERT SYSTEM



MUKEISH KUMAR
A/L N HARE HARAN



MUHAMMAD AKMAL
BIN ROSZAHAN



MUHAMMAD IRHAM
BIN ABDUL RAHIM

SUPERVISOR :
EN. MOHD ZULKARNAEN BIN MOHD IBRAHIM

ABSTRACT

Road crashes are serious concerns globally as they claim and cause more than 1.35 million fatalities and up to 50 million resulted injuries each year. Previous studies showed that one of the causes of vehicle crashes is failure to turn off turn signals after a turn by motorists. Not only that, motorist forgetting to turn off their turn signal can make other road users also think that a motorist will be turning or might pull out in front of them, and this can increase the risk of accidents to happen. After monitoring and researching about this issue, a turn signal alert system with the function to notify all motorist to turn off their turn signal is designed to help reduce this issue.

OBJECTIVE

- To create a turn off signal alert system that uses vibration to notify motorist to turn off their turn signal
- To reduce accidents that involves motorcyclist forgetting to turn off their signal occur

METHODOLOGY

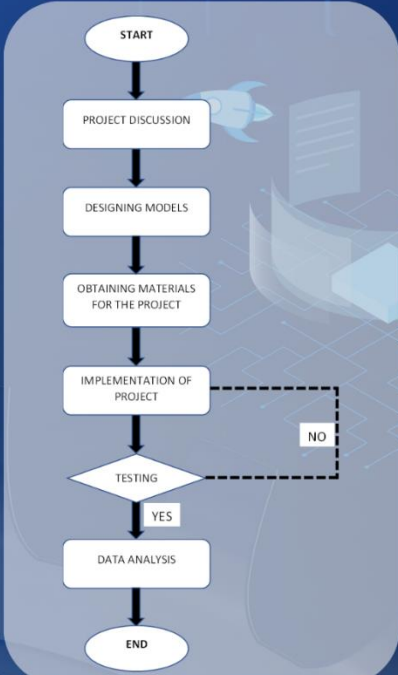

PRODUCT DESCRIPTION



The way this project function is when the turn signal is turned on, the coin vibrator will start to vibrate notifying the rider that their turn signal is on. The vibrator will continue to vibrate until the turn signal is turned off.

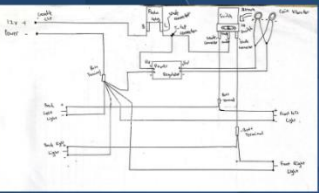

The circuit design involves attaching a 5V coin vibrator inside the turn signal switch box. The coin vibrator is connected to a voltage regulator. The positive wire of the voltage regulator is then connected to the load wire of a flasher relay, while the negative wire is connected to any negative wire of the circuit.

CONCLUSION

All the objectives were made from all the problem statements. The objective for this project along with the importance that will be cheap and light causing it to be more convenient for and even the scope of this project only. Thus, this new product could be used for daily routine with a really good care for a longer lifetime.

CONCLUSION

All the objectives were made from all the problem statements. The objective for this project along with the importance that will be cheap and light causing it to be more convenient for and even the scope of this project only. Thus, this new product could be used for daily routine with a really good care for a longer lifetime.

RESULT

Do you think this system can help notify the riders to turn off their turn signal? Adakah anda berpendapat sistem ini dapat membantu mempering...ikal untuk mematikan isyarat pusingan mereka?
30 responses



The pie chart shows that majority of respondent agreed that Turn Off Signal Alert System can help notify the riders to turn off their turn signal.

ORIGINALITY
MYIPO number : LY2023W01179

POLITEKNIK SULTAN SALHUDDIN ABDUL AZIZ SHAH
KEMENTERIAN PENDIDIKAN MALAYSIA
PERSIARAN USAHAWAN, SEKSYEN U1, 40150 SHAH ALAM
SELANGOR, MALAYSIA
TEL : 603-5163400
FAKS : 603-55691903

vii. Certificate of Gold Award of MICE



The certificate features a background of purple and blue geometric shapes and a network of white lines. At the top left is the Malaysian coat of arms. To its right is the logo for 'KEMENTERIAN PENDIDIKAN TINGGI' and 'JABATAN PENDIDIKAN POLITEKNIK DAN KOLEJ KOMUNITI'. Further right is the logo for 'POLITEKNIK MALAYSIA' and 'SULTAN SALAHUDDIN ABDUL AZIZ SHAH'. The main title 'SIJIL PENGHARGAAN' is in large, bold, black letters. Below it, the names of the supervisors are listed: 'MUHAMMAD AKMAL BIN ROSZAHAN', 'MUHAMMAD IRHAM BIN ABDUL RAHIM', and 'MUKEISH KUMAR A/L N HARE HARAN', followed by 'Penyelia' and 'MOHD ZULKARNAEN BIN MOHD IBRAHIM'. The project name 'TURN OFF SIGNAL ALERT SYSTEM' is listed under 'Projek'. A pink arrow-shaped box contains the word 'GOLD'. Below this, the event name 'PERTANDINGAN AKHIR PROJEK PELAJAR & PAMERAN INOUASI' is written in bold. The MICE logo (Mechanical Innovation Challenge and Exhibition) is centered. At the bottom, the text reads 'SESI 2 2022/2023', 'JABATAN KEJURUTERAAN MEKANIHAL', and '18 MEI 2023'. On the bottom left, there is a signature and the name 'DR. NORHAYATI BINTI ZAKARIA', 'PENGARAH', 'POLITEKNIK SULTAN SALAHUDDIN ABDUL AZIZ SHAH'. On the bottom right is the logo for 'IVET MALAYSIA'.

KEMENTERIAN PENDIDIKAN TINGGI
JABATAN PENDIDIKAN POLITEKNIK DAN KOLEJ KOMUNITI

POLITEKNIK
MALAYSIA
SULTAN SALAHUDDIN ABDUL AZIZ SHAH

SIJIL PENGHARGAAN

Adalah dengan ini mengakui bahawa

MUHAMMAD AKMAL BIN ROSZAHAN
MUHAMMAD IRHAM BIN ABDUL RAHIM
MUKEISH KUMAR A/L N HARE HARAN

Penyelia

MOHD ZULKARNAEN BIN MOHD IBRAHIM

Projek
TURN OFF SIGNAL ALERT SYSTEM

GOLD

PERTANDINGAN AKHIR PROJEK PELAJAR & PAMERAN INOUASI

MICE
Mechanical Innovation
Challenge and Exhibition

SESI 2 2022/2023
JABATAN KEJURUTERAAN MEKANIHAL
18 MEI 2023

DR. NORHAYATI BINTI ZAKARIA
PENGARAH
POLITEKNIK SULTAN SALAHUDDIN ABDUL AZIZ SHAH

IVET
MALAYSIA

viii. Certificate of Gold Award of PITEC 4



ix. Achieve Runner up in Mechanical Innovation and Challenge Exhibition (MICE)



x. Participated in PSA Innovation Technology and Commercialization (PITEC)

