



MECHANICAL ENGINEERING APARTMENT

DIPLOMA IN MECHANICAL ENGINEERING PACKAGING

DJJ40182 PROJECT PROPOSAL

DEVELOPMENT OF SOLAR GENERATOR WITH IOT SYSTEM

NO.	NAMA	MATRIC NO
1.	SITI NURJANNAH BINTI MOHD ALI	08DMP20F2004
2.	PUTERI YASMIN LIYANA BINTI MEGAT DAUD	08DMP20F2011

SUPERVISOR	DR. MOHD ELIAS BIN DAUD
-------------------	--------------------------------

ABSTRACT

The Solar Generator with IOT System is a project made to make it easier for users to use solar generators anywhere because they are easy to carry and can view information via phone only by using the Blynk application. The main objective of the idea to make this project is to produce a generator that uses solar energy to save electricity for consumers, consumers can use it when the electricity supply is cut off when sellers want to sell at the night market, and those who like camping can also use this generator. Even users can also view through the phone only using the Blynk application. In the production of this project, to ensure that this project is successful or not, we have made research findings that generators on the market are heavy and have a lot of space to store, most generators on the market have problems such as oil leaks, and produce loud noise. In addition, to create an IOT system we use ESP32 which is a microcontroller chip (SoC) because it is low-equipped with WiFi and Bluetooth. If the IOT system is placed on this generator it will make it easier for the user because the user only needs to connect the hotspot and the user can see the voltage, temperature, and battery via the Blynk app only. No need to go to the generator to see the information. The network service system is being expanded as the demands from various uses are increasing. Although many products have been created, there is still no generator that can be viewed only through the phone. This IOT system is designed to facilitate users. The proposed system is designed to know information such as voltage, battery, and temperature.

ABSTRAK

Solar Generetor with an IOT System adalah projek yang dibuat untuk memudahkan pengguna menggunakan solar generator di mana-mana kerana senang dibawa dan boleh tengok maklumat melalui telefon sahaja dengan menggunakan aplikasi blynk. Objektif utama idea untuk menghasilkan projek ini adalah untuk membuat generator yang menggunakan tenaga solar untuk menjimatkan tenaga elektrik kepada pengguna, pengguna boleh menggunakan ketika bekalan elektrik terputus, ketika peniaga ingin menjual di pasar malam dan untuk mereka yang suka berkhemah juga boleh menggunakan generator ini. Malah pengguna juga boleh melihat melalui telefon sahaja menggunakan aplikasi blynk. Dalam penghasilan projek ini, untuk memastikan projek ini berjaya atau tidak, kami telah membuat kajian mendapati generator yang ada dia pasaran adalah berat dan makan banyak ruang untuk menyimpan, kebanyakan generator di pasaran mempunyai masalah seperti terdapatnya kebocoran minyak, dan membuat bunyi yang bising. Di samping itu, untuk membuat IOT system kami menggunakan ESP32 adalah cip mikropengawal (SoC) kos rendah dilengkapi dengan WiFi dan Bluetooth.sekiranya IOT system diletakkan di generator ini akan memudahkan pengguna kerana, pengguna hanya perlu sambungkan hotspot dan pengguna boleh melihat voltage dan bateri melalui aplikasi blynk sahaja. Tidak perlu untuk pergi ke generator untuk melihat maklumat tersebut. Sistem perkhidmatan rangkaian semakin diperluas seiring permintaan dari berbagai penggunaan semakin meningkat. Walaupun banyak produk telah diciptakan, tapi masih belum ada generator yang boleh melihat memlalui telefon sahaja. IOT system ini dirancang memudahkan pengguna. Sistem yang dicadangkan ini dirancang untuk mengetahui maklumat seperti voltage dan bateri.

1.0 INTRODUCTION

A generator is a device which is used to produce electric energy, which can be stored in batteries or can be directly supplied to the homes, shops, offices, and others. It has a generator head with wires, spinning inside a magnetic field. The resulting electromagnetic induction makes electricity flow through the wires. Means that it transforms mechanical energy into electrical energy.

Regular generator came with some problems that we decided to make solar generator. It works the same way, converting solar energy to electrical energy. Solar generators are a great way to increase your power capacity. Mostly used to charge devices and run a few small appliances because they can only produce a limited amount of power. They are also good to have as a backup when the electricity goes out for a few hours.

With solar generator, it makes things easier to people especially to night market seller and people who like outdoor activity. It provides electricity to lamps, fan, and radio because not all places have the electricity supply provided. Example in public place, forest, beach etc. Not just that, a generator also helps in emergency moment such as flood. It can help people to charge up their phone to get help, at the same time saves their life.

The portable solar system, which consists of batteries, an inverter, a charge controller, and solar panels, is referred to as a solar generator in this context. We capture solar energy, store it, and then supply it back it to the appliances. The market for solar products is rapidly growing, and this growth now also includes portable Solar Generators in addition to rooftop units. We also add IOT system to our solar generator. The function is to read generator current voltage and battery through Blynk app. This make our solar generator different from other solar generator in market.

The proposed idea of the generator that has been designed use a solar energy, quiet, and easy to carry. It also came with an IOT system to read generator data through our devices such as smartphone and laptop.

1.0.1 DEFINITION

Generator that powered by solar energy based on IOT system.

1.1 OBJECTIVE

Our objective is to develop a generator that use solar energy. Next is to design an easy to carry generator. Then to develop a generator with an IOT system. Finally, to develop a solar generator that can solve problems.

1.2 PROBLEM STATEMENT

Generator requires lubrication to ensure smooth operation for a long period of times. The engine is lubricated by oil stored in pump. leaking oil on a generator can be caused by loose components, deterioration due to age, and incorrectly fitted components. The effect to generator is damaged engine if not repaired in a short time, and losses to user. (Jiangsu 2021)

Solar generator no need an oil to operation or for lubrication. It just uses natural energy that always can be reuse.

The following problem is a loud noise. This is a combination of sound produced by the engine, cooling fan, alternator and engine. Mechanical vibration of structural components can also cause mechanical noise. This disturbing the peace of other peoples and can be noise pollution. It also makes a communication hard between seller and customer in a night market. (Stellar 2021)

Our solar generator is quiet despite for not having any moving parts. This significantly reduces the amount of noise they produce while running.

Regular generator are big and take up too much space. It hard to be stored and not suitable to everyday use too. The size will take too much space in a transportation and be troublesome to carry. It also heavy and can cause backache to the person that carry it. To prevent that, the user may use trolley to move the generator but it will be complicated and takes times to completed the process.

Because of solar generator don't have many items, they are small, easy to carry and be stored.

1.3 SIGNIFICANCE STUDY

The aim for this study is to make a solar generator that come with IOT system. This study covers several aspects as generator function, solar energy and IOT system. Finding from this study is solar generator with IOT system will facilitate those who need backup power or who need to use electric power. Then, it can solve regular generator problems and the IOT system will make it easier to read generator current data.

2.0 LITERATURE REVIEW

2.1 CONCEPT/ THEORY

The idea behind this project is to transform solar energy into electrical energy and control the solar generator using smartphones which can be useful in emergencies, facilitate the user or specific circumstances. Additionally, the battery stores this electrical energy, which is linked to a switch that must be turned on in order to activate it. Theoretically, this is possible since the installed power controller charge can regulate the quantity of solar energy collected to be transformed into electrical energy before being directed to the appropriate size battery as portable energy storage.

2.2 SOLAR GENERATOR

A photovoltaic (PV) power system that collects and disperses solar energy is technically referred to as a "solar generator" under this definition. In a grid-connected or hybrid solar energy system, a solar generator can be added to serve as a backup power source if the utility grid goes offline. In this situation, it may be possible to integrate a solar battery into your home's electrical system to enable you to continue using your devices through the property's plugs and outlets. (Brian Church, 2022)

2.3 SOLAR ENERGY

Solar energy, the sun's rays that can ignite chemical reactions, produce heat, or create electricity. The total solar energy incident on Earth far exceeds both the present and future energy needs of the planet. This highly diffused source might potentially provide all of the energy required in the future if properly harnessed. Due to its limitless supply and lack of environmental impact compared to the finite fossil fuels coal, petroleum, and natural gas, solar energy is predicted to gain popularity as a renewable energy source in the twenty-first century. (Ashok S., 2022) Sunlight is by far the most powerful energy source that Earth receives, but its intensity at the surface of the planet is rather low. The Sun is a very potent energy source. Essentially, this is because of the massive radial radiation radiating from the far-off Sun. The atmosphere and clouds of Earth absorb or scatter up to 54% of the incoming sunlight, which results in a relatively small additional loss. Nearly half of the sunlight that reaches the ground is visible light, followed by infrared radiation at a ratio of 45%, ultraviolet radiation at a lower rate, and other electromagnetic radiation at a lower rate.

2.4 ESP32

ESP32 is created by Espressif Systems with a series of SoC (System on a Chip) and modules which are low cost with low power consumption. ESP32 can perform as a complete standalone system or as a slave device to a host MCU, reducing communication stack overhead on the main application processor. It also can interface with other systems to provide Wi-Fi and Bluetooth functionality through its SPI / SDIO or I2C / UART interfaces. Then, ESP32 is a series of low-power system on a chip microcontrollers with integrated Wi-Fi and dual-mode Bluetooth. Additionally, the ESP32 comes with touch-sensing pins that can be used to wake the ESP32 from deep sleep, a built-in hall effect sensor, and a built-in temperature sensor. Next, ESP32 is capable of functioning reliably in industrial environments, with an operating temperature ranging from -40°C to $+125^{\circ}\text{C}$. Powered by advanced calibration circuitries, ESP32 can dynamically remove external circuit imperfections and adapt to changes in external conditions. Not just that, ESP32 is highly-integrated with in-built antenna switches, RF balun, power amplifier, low-noise receive amplifier, filters, and power management modules. ESP32 adds priceless functionality and versatility to your applications with minimal Printed Circuit Board (PCB) requirements. It is a new generation of boards and microcontrollers for the world of IoT, home automation and connected objects.

2.5 IOT (Internet Of things)

The Internet of Things (IoT) is a vast network of interconnected devices and people, all of which gather and exchange information about their environments and how they are used. That encompasses an extraordinary variety of items of all sizes and shapes, such as self-driving cars with sophisticated sensors that can detect objects in their path and smart microwaves that cook food for you automatically. It also includes wearable fitness devices that monitor your heart rate and the number of steps you take each day in order to provide you with personalized exercise recommendations. Even connected footballs are available that can monitor how far and quickly they are thrown and record those facts using an app for future practice. (Clark, Jen. 2020).

Bluetooth is a technology that transfers data (files, voice, numbers, etc.) from one device to another without using wires (wireless). This module has 4 pins of which all four will be connected directly to the Arduino Uno. (Grokhotkov, I., 2017) The ESP8266 Wi-Fi module is a self-contained SOC with an integrated TCP/IP protocol stack that can provide microcontroller access to your Wi-Fi network. The ESP8266 is capable of either hosting applications or offloading all Wi-Fi network functions from other application processors. Each ESP8266 module comes pre-programmed with the firm AT firmware set, which means, you can connect this device to your Arduino device and get more Wi-Fi capabilities as the Wi-Fi Shield offers.

2.6 BLYNK APP

The Internet of Things was the focus of Blynk's design. It has several fascinating features, like the ability to remotely control gear, visualize data, store data, and display sensor data. (Bayborodin, P., 2021). Blynk is a simple and powerful no-code application builder where you can prototype, deploy, and manage connected electronic devices at any scale - from your personal projects to millions of products used by your clients. Connect your hardware like ESP32, Arduino, Raspberry Pi, Particle, SparkFun, Adafruit, TI, and others to the cloud and use a wide variety of widgets like buttons, sliders, charts, etc. to build a user interface to visualize sensor data and control any electronics.

Features

Similar API & UI for all supported hardware & devices

Connection to the cloud using:

- Wi-Fi
- Bluetooth and BLE
- Ethernet
- USB (Serial)
- Cellular (GSM, 3G,4G,5G)

- Device-to-Device communication using Bridge Widget.
- Easy to integrate and add new functionality using virtual pins.
- Direct pin manipulation with no code writing.
- History data monitoring via Super Chart widget.

2.7 Comparison Between Available Solar Generator In The Market

Below are some explanations on previous work regarding event solar generator

Author/Date	Topic/ Focus/ Question	Conceptual/ Theoretical Framework	Paradigm/ Method	Context/ Setting/ Sample	Gaps/ Weakness	Reference
York Wu (2012)	Explorer 1000 Portable power Station “Designed to use during emergency situations involving power outages.	A power station, combined with a solar panel or two and the right weather, can provide seemingly endless power.	Use solar panel to charge the portable power station.	Provides AC output and DC output and lots of charging options	-Some people complain of cheap- feeling build quality. -Not use IOT system. -Confusing charge times	https://www.gearpatrol.com/outdoors/a40770753/jackery-explorer-1000-Power-station/
Robert Workman (2013)	Goal Zero Yeti 1500X “Designed for people who likes to go camping and to spend several days or longer off the grid, has a lot of electronics to charge, or are looking for a solar powered generator	Has a built- in solar charge controller, as well as a built-in 120-volt AC inverter, so can plug standard household electronics into it.	Charging using solar panel and AC outlet	Can handle large appliances like refrigerators and washing machines	-Quite expensive -Heavy - Not use IOT system.	https://goalzero.com/products/goal-zero-yeti-1500x-portable-power-station

	to run the camper.”					
Aukey Lu Haichuan (2013)	AUKEY PowerTitan 300 “Designed for users who can charge all their necessary accessories while there are out camping or on a trek and can be helpful to users who want to charge multiple devices on the go.”	This power station has enough ports to connect and power almost anything you can imagine, and it’s not terribly expensive.	Charging using solar panel, AC outlet and car charger.	As for the ports, provides 300 features 3x USB-A ports, 1x USB -C PD (60W) port, 2x 12V DC output, and a single 110V AC outlet for TVs and CPAP machines.	- Not use IOT system. - The screen on the power station is not brighter, it can be hard to see in full sunlight.	pcworld.com/article/395159/aukey-powertitan-300-power-station-review.html

<p>Siti Nurjannah and Puteri Yasmin Liyana (2022)</p>	<p>Generator Powered by Solar with IOT System</p> <p>“Designed to help users who like to be camping, night market traders, when electricity supply cut off and a flood disaster occur and can monitor the generator anywhere.”</p>	<p>A generator combined with solar panel and using IOT system to monitor the solar generator</p>	<p>Charging the solar generator From solar panel</p>	<p>Provides AC output and DC output and lots of charging options</p>	<p>-Use IOT system</p> <p>Lightweight</p> <p>-Easy to carry</p>	
---	--	--	--	--	---	--

Table 1; Product in market comparison with our product

3.0 METHODOLOGY

3.1 INTRODUCTION

A research study's evidence is gathered through the use of a methodology, which is a method and approach for creating, gathering, and assessing data. The most effective strategy for addressing a problem under research is demonstrated by methodology. By describing the research process, the methodology aims to help you use the approach more effectively.

In this chapter, student will describe the research methodology used for this project. Then, explain how to design the proposed application, elaborates the procedure and process as well provide methods on how to analyze the collected data.

3.2 FLOWCHART

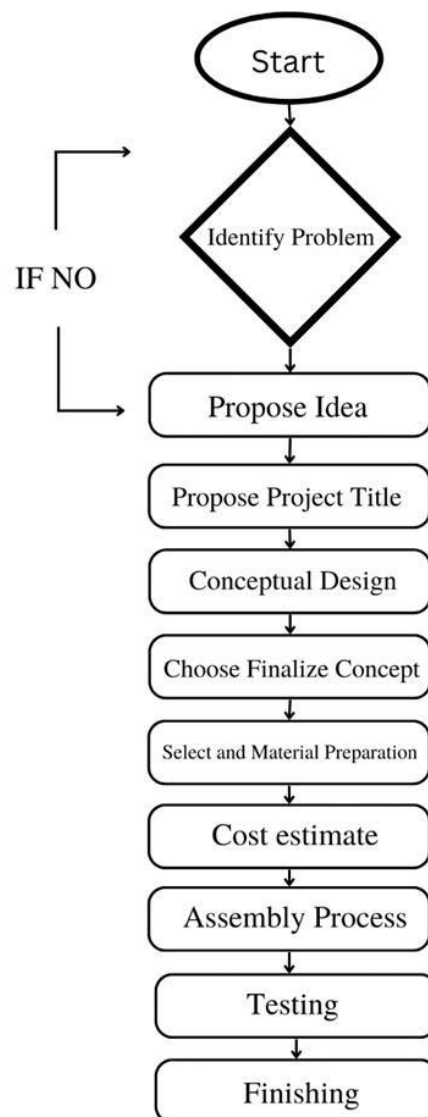

3.3 RESEARCH METHODOLOGY

3.3.1 SOLAR GENERATOR

The term solar generator usually refers to the combination of portable solar panels, battery, solar charge controller and inverter into a single device that allows you to capture, store, and distribute power from the sun. An inverter then converts that energy into alternating current (AC power) before it is released for use of electrical appliances. Solar generators will get power from solar panel that been capturing the sun energy.

3.3.2 SOLAR PANEL

Solar panels are those devices which are used to absorb the sun energy and convert them into electricity or heat. It made from photovoltaic cells. Photovoltaic cells are sandwiched between layers of semi-conducting materials such as silicon. Each layer has different electronic properties that energise when hit by photons from sunlight, creating an electric field. Solar panel will transfer the electric energy to solar charge controller, then go to the battery. Battery will turn on the inverter and make it to electrical appliances.

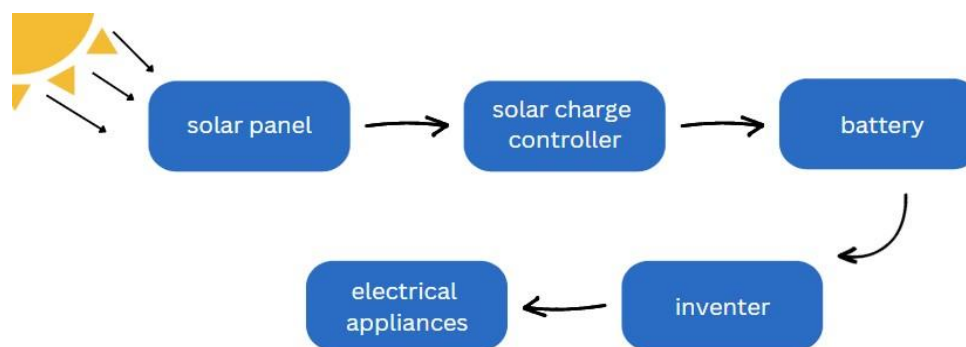

Figure 1; Process of energy transfer from sun to electrical devices.

3.3.3 IOT SYSTEM

In this project, IOT system will pair with solar panel. This system will connect to generator and collect it current voltage and battery. The collected data can be read from electronic devices such as smartphone and laptop. The Blynk app must installed first on these devices. We can connect the app with WI-FI, 3G and others. In this way, people don't need to go outside to see generator batery and voltage while it being charged. Just open the Blynk app to see the data, as long the IOT system is connected to generator.

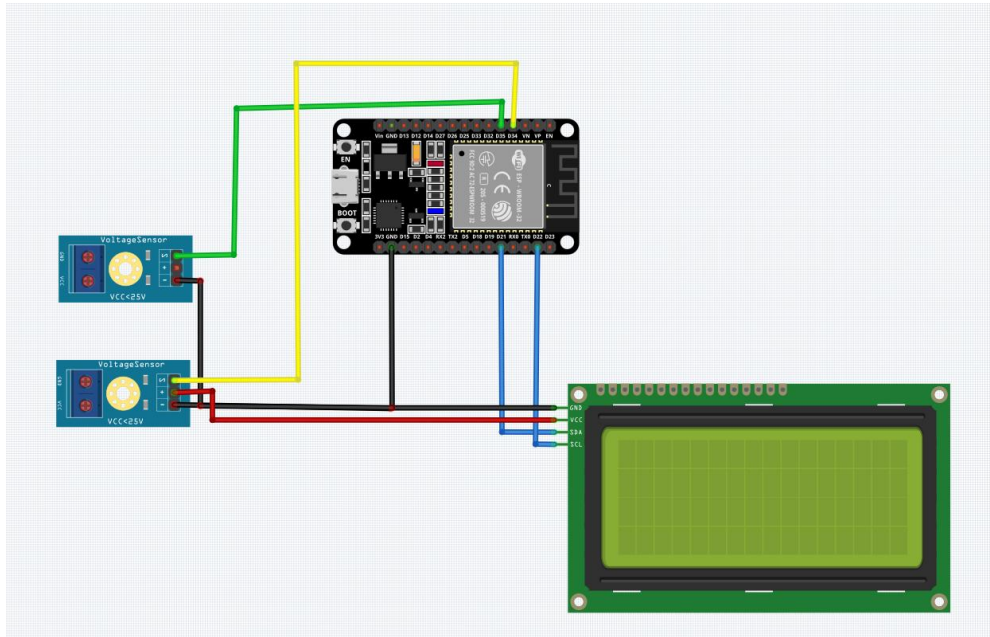

Figure 2; IOT system circuit arrangement.

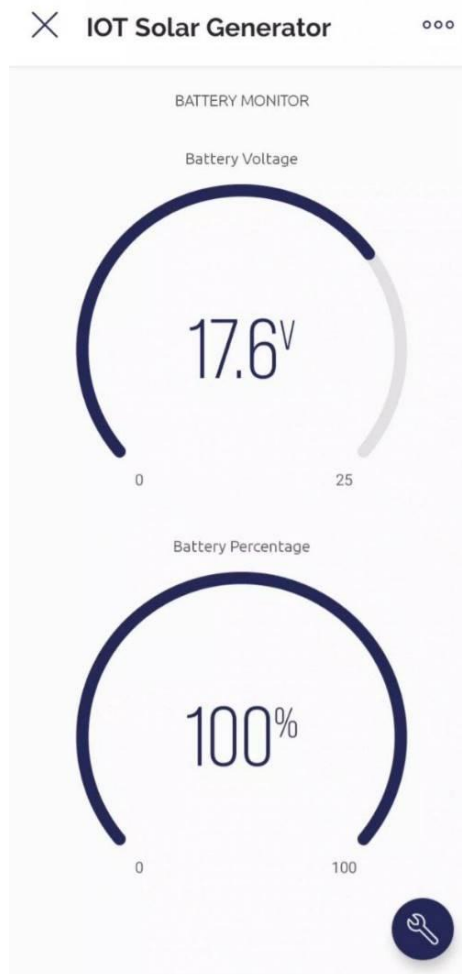

Figure 3; Blynk app usage on a smartphone.

Next, the coding used to make IOT system functioning. The arduino app is installed first in laptop. It must connect with hotspot on smartphone that have a Blynk app.

```
#define BLYNK_TEMPLATE_ID "TMPL6dJ9-129m"
#define BLYNK_TEMPLATE_NAME "Quickstart Template"
#define BLYNK_AUTH_TOKEN "53hQ_fMrih9eifApBYiwpOEvsrypaQAY"
#include <Wire.h>
#include <LiquidCrystal_I2C.h>
LiquidCrystal_I2C lcd(0x27, 20, 4);
#define BLYNK_PRINT Serial
#include <WiFi.h>
#include <WiFiClient.h>
#include <BlynkSimpleEsp32.h>
#include <DHT.h>

char ssid[] = "farriz"; //your id hotspot
char pass[] = "apeapeje"; //your pass hotspot

#define DHTPIN 13
#define DHTTYPE DHT11 // DHT 11
DHT dht(DHTPIN, DHTTYPE);
BlynkTimer timer;

const int batterySensorPin = 34; // sensor pin
const int voltageSensorPin = 35;
float vIn;
float vIn2; // measured voltage (3.3V = max. 16.5V, 5V = max
25V)
float vOut;
float vOut2;
float batterySensorVal; // value on pin D2 (0 - 1023)
float voltageSensorVal;
float voltage_percentage;
float battery_percentage;
const float factor = 5.128; // reduction factor of the Voltage Sensor shield
const float vCC = 5.00;

void setup() {
```

```

Serial.begin(115200); //correction
lcd.init(); //correction
lcd.backlight();
dht.begin();
lcd.setCursor(4,1);
lcd.print ("IOT SOLAR");
lcd.setCursor(4,2);
lcd.print ("GENERATOR ");
delay(1000);
Blynk.begin(BLYNK_AUTH_TOKEN, ssid, pass);
timer.setInterval(1000L, sendSensor);
}

void sendSensor()
{
  float h = dht.readHumidity();
  float t = dht.readTemperature();

  if (isnan(h) || isnan(t)) {
    Serial.println("Failed to read from DHT sensor!");
    return;
  }

  Blynk.virtualWrite(V2, t); //Blynk PIN temperature
  Blynk.virtualWrite(V3, h); //Blynk PIN humidity
}

void batteryReading(){ //battery
  batterySensorVal = analogRead(batterySensorPin); // read the current sensor value
(0 - 1023)
  vOut = (batterySensorVal / 1024) * vCC; // convert the value to the real
voltage on the analog pin
  vIn = (vOut * factor)/5.00; // convert the voltage on the source by
multiplying with the factor
  Serial.print("Battery = ");
  Serial.print(vIn);
  Serial.println("V");
  Serial.print(battery_percentage);
  lcd.setCursor(0,2);

```

```

    lcd.print ("Battery = ");
    battery_percentage=(vIn/12)*100;
    lcd.print(battery_percentage);
    lcd.println("%");
    delay(1000);
    Blynk.virtualWrite(V0,battery_percentage);
}

void VoltageReading(){ //solar
    voltageSensorVal = analogRead(voltageSensorPin); // read the current sensor
    value (0 - 1023)
    vOut2 = (voltageSensorVal / 1024) * vCC; // convert the value to the real
    voltage on the analog pin
    vIn2 = (vOut2 * factor)/5.00; // convert the voltage on the source by
    multiplying with the factor
    Serial.print("Voltage = ");
    Serial.print(vIn2);
    Serial.println("V");
    Serial.print(voltage_percentage);
    lcd.setCursor(0,1);
    lcd.print ("Voltage = ");
    lcd.print(vIn2);
    lcd.println("V");
    voltage_percentage=(vIn2/12)*100;
    delay(1000);
    Blynk.virtualWrite(V1,vIn2);
}

void loop() {
    sendSensor();
    VoltageReading();
    batteryReading();
    Blynk.run();
    timer.run();
}

```



```
iot_generator_1 | Arduino 1.8.19
File Edit Sketch Tools Help
Upload
iot_generator_1
#define BLYNK_TEMPLATE_ID "TMPL6dJ9-129m"
#define BLYNK_TEMPLATE_NAME "Quickstart Template"
#define BLYNK_AUTH_TOKEN "53hQ_fMrh9eifApBYiwP0EvsrypaQAY"
#include <Wire.h>
#include <LiquidCrystal_I2C.h>
LiquidCrystal_I2C lcd(0x27, 20, 4);
#define BLYNK_PRINT Serial
#include <WiFi.h>
#include <WiFiClient.h>
#include <BlynkSimpleEsp32.h>
#include <DHT.h>

char ssid[] = "farriz"; //your id hotspot
char pass[] = "apeapeje"; //your pass hotspot

#define DHTPIN 13
#define DHTTYPE DHT11 // DHT 11
DHT dht(DHTPIN, DHTTYPE);
BlynkTimer timer;

const int batterySensorPin = 34; // sensor pin
const int voltageSensorPin = 35;
float vIn;
float vIn2; // measured voltage (3.3V = max. 16.5V, 5V = max 25V)
float vOut;
float vOut2;
float batterySensorVal; // value on pin D2 (0 - 1023)
float voltageSensorVal;
float voltage_percentage;
float battery_percentage;
const float factor = 5.128; // reduction factor of the Voltage Sensor shield
const float vCC = 5.00;
```

Figure 4; Some of the coding that have be put in arduino software

3.4 PROJECT ANALYSIS

3.4.1 SOLAR SYSTEM CALCULATION

Determine electrical load;

The first step in designing a solar generator, we need to find the total power and energy consumption of all loads that need to be supplied by solar PV system. The calculation needed are:

i. Total watt-hours per day for load.

$$3 \text{ LED bulb} = 3 \times 3\text{W} = 9\text{W}$$

$$2 \text{ small fans} = 2 \times 5\text{W} = 10\text{W}$$

$$2 \text{ smartphone charging} = 2 \times 10\text{W} = 20\text{W}$$

$$1 \text{ tablet charging} = 1 \times 11\text{W} = 11\text{W}$$

$$\text{Total watt} = 50 \text{ W}$$

$$\text{Total watt-hours} = \text{Total Watt} \times \text{Total Hours}$$

$$\text{Total WH} = 50 \times 5 = 250 \text{ WH}$$

ii. Inverter selection

$$\text{Electrical load} = 250 \text{ WH}$$

$$\text{AC load} = 300 \text{ W}$$

$$\text{DC voltage} = 12 \text{ V}$$

DC current required

$$P = V \times I$$

$$I = P/V = 50/12$$

$$I = 4.2 \text{ A}$$

Choose 300W inverter

iii. Battery size (AH)

$$\text{Formula} = \text{WH}/\text{V}$$

$$= 250/12$$

$$= 21 \text{ AH}$$

$$\text{Battery charging current} = 21 \times 10\%$$

$$= 2.1 \text{ A}$$

Choose 26 AH battery

iv. Solar panel current

$$\text{Battery charging current} + \text{electric load current}$$

$$= 2.1 + 4.2$$

$$= 6.3 \text{ A}$$

$$\text{Solar panel power} = \text{V} \times \text{I}$$

$$= 12 \times 6.3$$

$$= 75.6 \text{ W}$$

Choose 50W solar panel

3.4.2 DATA COLLECTED

CHARGING GENERATOR USING SOLAR PANEL

THAT WEEK MOSTLY RAINY AND CLOUDY, THAT'S WHY IT'S HARD FOR BATTERY TO FULL

TARIKH	TIME	BAR BATTERY
26.4.2023	10 AM-3.30 PM	2 BAR BATTERY
27.4.2023	8 AM-2PM	2 BAR BATTERY
28.4.2023	8 AM-5PM	2 BAR BATTERY
29.4.2023	8 AM-6 PM	2 BAR BATTERY
30.4.2023	8 AM-4.47 PM	3 BAR BATTERY
1.5.2023	8 AM-4 PM	3 BAR BATTERY

FOR THIS TABLE,

TARIKH	TIME	BAR BATTERY
4.5.2023	8 AM-6 PM	3 BAR BATTERY
5.5.2023	8 AM-4.36 PM	4 BAR BATTERY
6.5.2023	8 AM-6 PM	4 BAR BATTERY
7.5.2023	8 AM- 3.48 PM	5 BAR BATTERY

DATA COLLECTION WHEN USING THE GENERATOR

TARIKH	TIME	BAR BATTERY	ITEM
8.5.2023	1 PM-12 AM	5 BAR BATTERY	2 USB LED LIGHT, PORTABLE FAN
9.5.2023	8 AM-10 PM	5 BAR BATTERY	2 USB LED LIGHT, PORTABLE FAN
10.5.2023	8 AM-11 PM	5 BAR TO 4 BAR BATTERY	PHONE, PORTABLE FAN, USB LED LIGHT
11.5.2023	1PM-12 AM	4 BAR BATTERY	DRILL, PORTABLE FAN, 2 USB LED LIGHT
12.5.2023	10 AM- 11.30 PM	4 BAR TO 3 BAR BATTERY	2 USB LED LIGHT, PORTABLE FAN
13.5.2023	9.30 AM-11PM	3 BAR BATTERY	PHONE, PORTABLE FAN, USB LED LIGHT

3.5 DATA RESEARCH

3.5.1 DATA STUDY

This is a google form that we shared to get people feedback about this solar generator. 31 responders have answered the question below, both male and female.

Do you ever heard about solar generator with IOT system?

31 responses

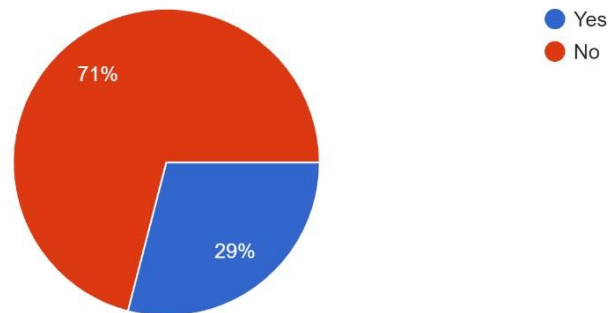

Do you think IOT system makes solar generator more effective?

30 responses

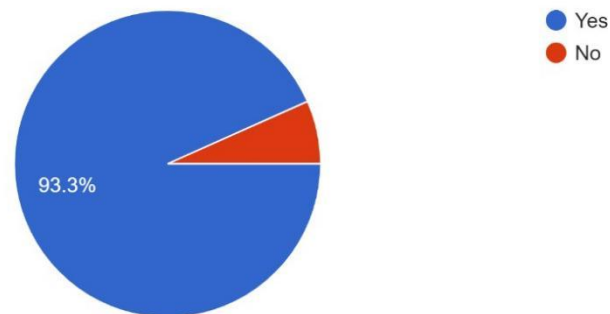

Do you think solar generator can help in emergency time such as flood?

31 responses

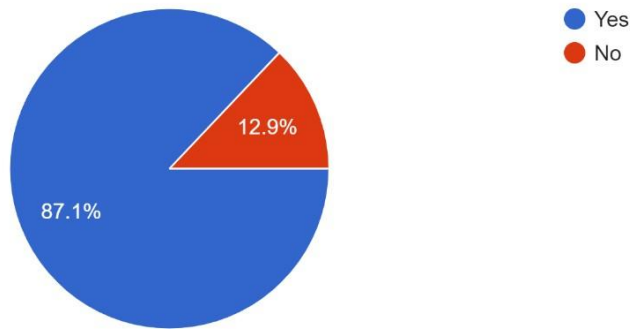

Do you think solar generator can save electric?

31 responses

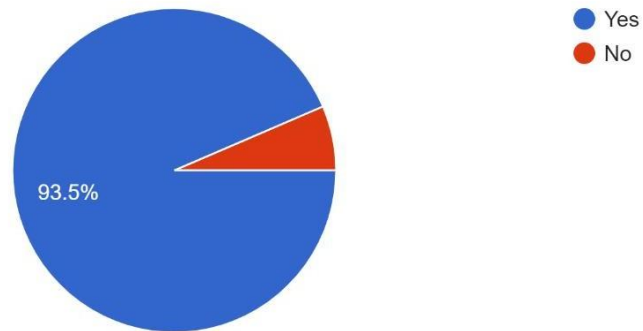

Do you will buy this solar generator with IOT system if the price is reasonable?

31 responses

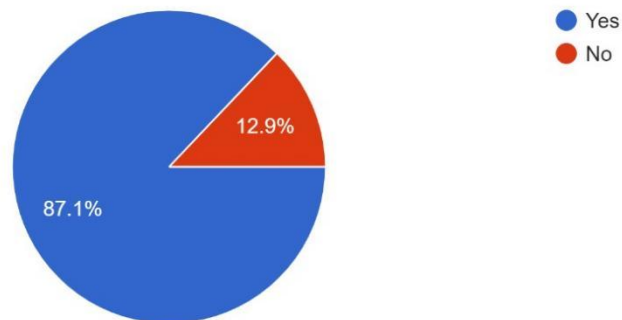

3.5.2 DATA ANALYSIS

22 responders never heard of solar generator with IOT system and other 9 ever heard about this. A lot of responders think IOT system make solar generator more effective, 28 responders have said yes to the question. Then it takes 27 of responders to agreed that solar generator can help in emergency time such a flood

Not just that, 29 responders agreed that solar generator can save electric. The last one, 27 agreed to buy this solar generator with IOT system if the price is reasonable.

From this data, we get to know that this solar generator with IOT system can make it to the market and got a change to help targeted people.

3.6 PRODUCT DESIGN

3.6.1 INITIAL SKECTH

This solar generator uses toolbox that the long is 30cm, the width is 20 cm, and the height is 15 cm. It came with a 50-Watt solar panel for charging the generator. The size is 65 cm long and 44 cm width. Then, the IOT system stored in a box that the size is 20 cm long, 5 cm for the height and 15 cm for the width.

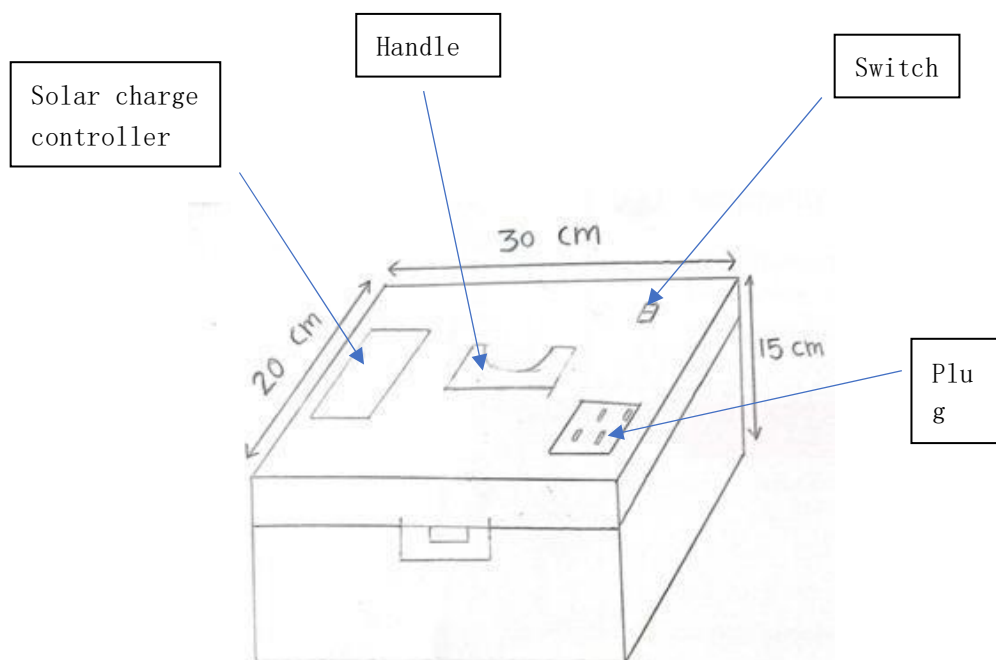

Figure 3; Solar generator product design

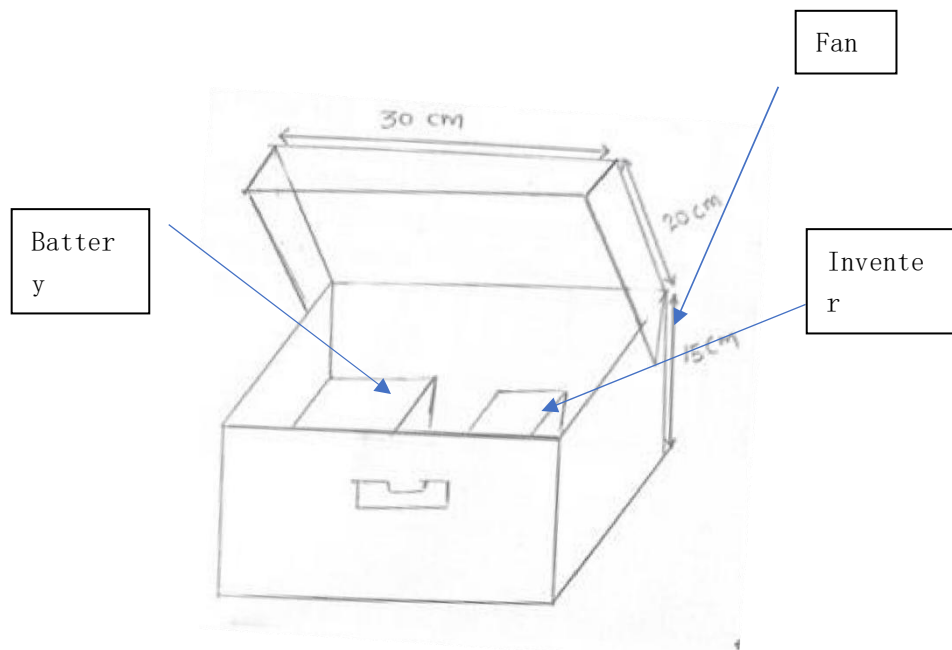

Figure 4; Product design when been open

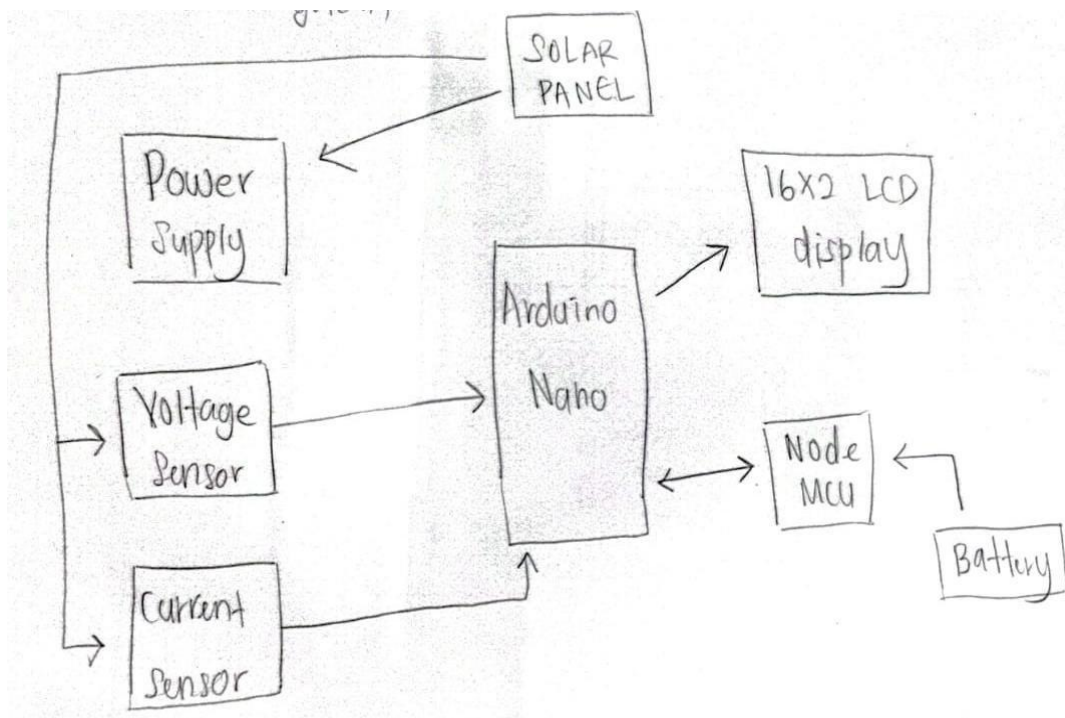

Figure 5; IOT system labeled diagram

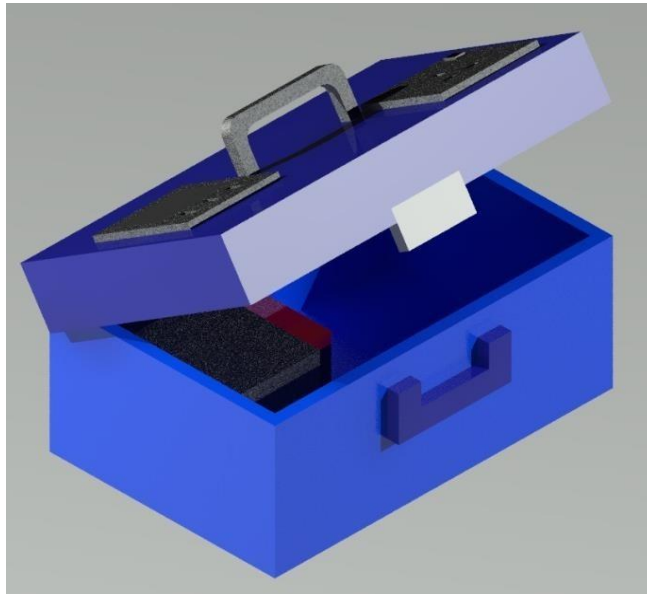

Figure 8; CAD drawing when product been open

3.5.3 FINAL PRODUCT

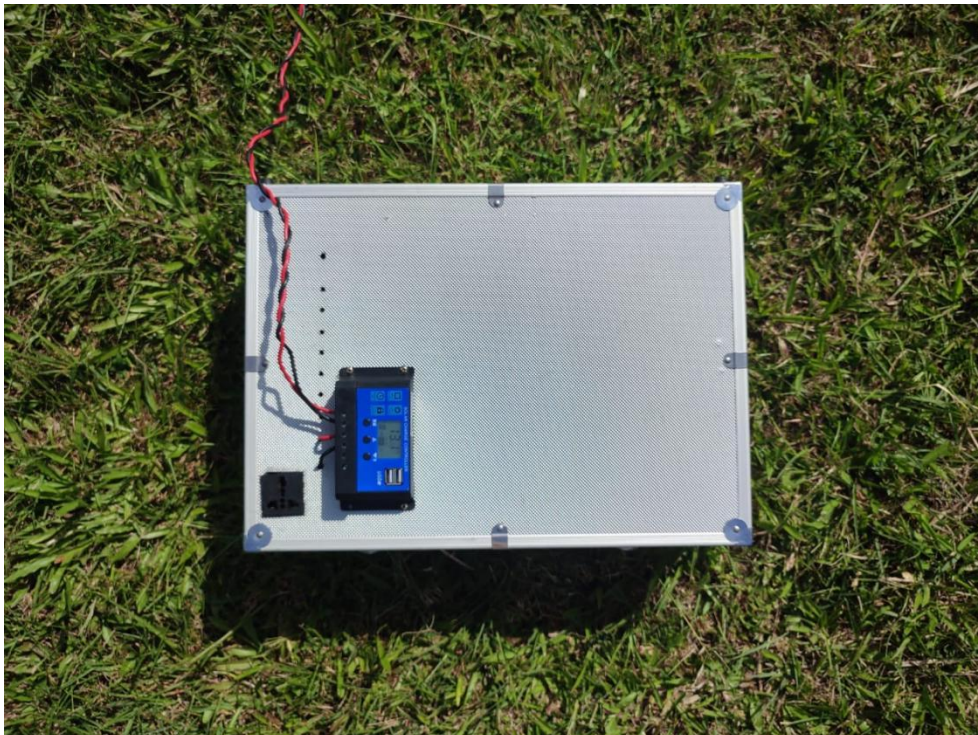

Figure 1; Solar Generator









Figure 2: Inside the solar generator



Figure 3; When the solar generator is charging

3.7 LIST OF COMPONENT AND MATERIALS

NO.	MATERIAL	PICTURE
1.	Toolbox	 A black and yellow Stanley toolbox with a handle on top and the brand name 'STANLEY' printed on the front.
2.	26 AH battery	 A black rectangular battery with 'MIGHTYMAX BATTERY' and '26AH' printed on the front. It has a CE mark and other technical specifications.
3.	300-Watt inverter	 A blue rectangular inverter with a yellow label that says '300W'. It has a red and black terminal on the left side.
4.	solar charge controller	 A blue and black solar charge controller with a digital display showing '18.8V'. It has several ports and buttons on the front.
5.	Solar panel 50-Watt	 A rectangular solar panel with a grid of cells and a white frame.
6.	Switch and plug	 A gold-colored wall switch and a black USB plug.







7.	Small fan	
----	-----------	---

Table 2; Material needed for solar generator

1.	Wire	
2.	Chipboard screw	
3.	PVA glue	
4.	Plywood	
5.	ESP32 with base	
6.	Voltage sensor X2	



7.	16x2 LCD display	
8.	Plastic container	

Table 2; List of component and material needed in IOT system

3.8 KEY MILESTONE

NUM.	MILESTONE	WEEK
1	Title is chosen	WEEK 6
2	Model and proposal progress	WEEK 8
3	Model and proposal complete	WEEK 12
4	Model submission	WEEK 13
5	Proposal submission	WEEK 14
6	Requirement and material gathering	WEEK 16
7	Project progress	WEEK 18
8	Prototype development complete	WEEK 24
9	Report and slide presentation progress	WEEK 25
10	Report and slide completed	WEEK 26
11	Report submission	WEEK 27
12	Project submission and presentation	WEEK 28

Table 3; Project Key Milestone

3.9 GANTT CHART

PROJECT ACTIVITI WEEK	W1	W2	W3	W4	W5	W6	W7	W8	W9	W10	W11	W12	W13	W14
Requirement gathering	Yellow	Blue												
Build a solar generator		Yellow	Blue	Blue	Blue									
Run a test			Blue	Blue	Blue	Blue	Blue	Blue	Blue	Blue	Blue			
Take a data				Blue	Blue	Blue	Blue	Blue	Blue	Blue	Blue			
Build an IOT system									Yellow	Blue	Blue	Blue	Blue	
Test on Blynk app												Yellow	Blue	
Refine					Blue	Blue	Blue	Blue	Blue	Blue	Blue	Blue	Blue	
Testing product usability										Yellow	Blue	Blue	Blue	
Prepare report										Yellow	Blue	Blue	Blue	
Make a project poster											Yellow	Blue	Blue	
Prepare presentation slide												Yellow	Blue	
Prepare presentation video												Yellow	Blue	
Presentation												Yellow	Blue	
Report Submission													Yellow	Blue

Table 4; FYP 1 Gantt Chart

4.0 EXPECTED RESULT

We expected to have a solar generator that can solve problems. The problems are oil leakage, loud noise and a heavy weight. Solar energy, radiation from the sun capable of producing heat, causing chemical reactions, or generating electricity. That is the reason we want to make solar generator because no need a diesel, quiet and lightweight. We designed the product to make it easy to carry just to an addiction the user.

Then, we hope this solar generator can help night market seller and people who loves outdoor activities. This solar generator will ease things for them with all the advantages. With 26 AH battery, it can use to small electric appliances. Example, 2 rechargeable fans, 3 LED bulb, 2 USB phone charge can endure for 50 to 60 hours. This has enough time for almost a week usage. It can be charges under the sun during daytime one or two times per week.

Other than that, we want to develop a different solar generator from market. That is why IOT system has been add to this project. The IOT system will ease a user to know generator current voltage and battery. A user can see generator data in Blynk app that has been installed in their smartphone. In this way, a user does not need to go outside to see generator current voltage and battery. Just open the Blynk app on their smartphone. We use Esp32 because it has several facilities for communicating with a computer or other microcontrollers use Type-B Micro USB. One of the IOT system component is voltage sensor to measures voltage.

5.0 DISCUSSION

This introduction is intended to explain how this project was introduced so that it can be discussed. The investigations have outlined where inspirations and ideas come from. The relevance of this project, along with its purpose of comfort and mildness, could make it more practical for the project's narrow scope. We hope that by understanding the introduction, you will be able to define the context or design of this project and have a sense of how it operates.

Next, the literature review is important to showcase all the studies of types and components to enhance the knowledge on this project. After a lot of guidelines and methods were discussed and research was done, we would like to create a generator with the innovation of add solar panel and IOT system to our product called Solar Generator with IOT system. Which is Solar Generator with IOT system will be using Solar panel to produce electricity and can monitor the solar generator with Blynk app. Besides that, with solar generator it's easy to carry anywhere and can use for people who likes camping, night market traders, to use when flood disaster or can be as emergencies when power outages. This implementation was able to achieve the objectives of our study.

The method of renovating the solar generator with an IOT system is also covered in detail. Flowcharts, tools, components, project methodology, and design are all discussed in this chapter as well. Then, we discover how to build an IOT system and do renovations. In addition, we are also make a design of solar generator that can solve problem. We make an initial sketch with labeled equipment and dimension of long, height and width. Other than initial sketch, we make an AutoCAD drawing for a clear and sharp look. Then, we make a table of list of equipment and material we will use in this project. All the list is checked properly before being put on the table. With this table, it easier for us to calculate the total cost from this project. Later, we make a key milestone from week 1 to week 28, total of two semesters. Our milestone contains work progress such as model making, proposal and report preparing, then building a prototype. Work submission is also put in the table for us to identify and correct things. Next, we are also do Gantt Chart from this semester until next semester. Our Gantt Chart contain more detailed information and work process we be running on this project. Finally, we make an expected result on this project.

6.0 CONCLUSION

In conclusion, we have developed a Solar Generator with IOT system based on the studies and observations made, which will help overcome any issues or drawbacks found when using it, make it simple to carry from one location to another, and maintain the component quality. Due of its portability and compactness, the design is user-friendly and suitable for all communities to purchase. With solar generator with IOT system you can power essential electronic devices without an enormous investment. An easy operational mode made the solar generators suitable for emergency backup power in your houses, night market, camping and floods disaster. Then, we are hoping this product can be successful and can make it to market. We be happy to see this product help people and make their life easier.

7.0 REFERENCE

- Bayborodin, P. (2016, February 2). Blynk IOT platform: For businesses and developers. Blynk IoT platform: for businesses and developers. Retrieved 1AD, from <https://blynk.io/>
- Staff, C., & Says:, D. (2022, January 11). What is ESP32, how it works and what you can do with esp32?. Circuit Schools. <https://www.circuitschools.com/what-is-esp32-how-it-works-and-what-you-can-do-with-esp32/>
- Jiangsu Starlight Electricity Equipments Co. (2021, August 6). Diesel generating set, emergency diesel generators: Starlight Generator. Diesel Generating Set, Emergency Diesel Generators Starlight Generator. Retrieved from <https://www.dieselgeneratortech.com/>
- Syed Zainal Nasir (2021, December 13). Introduction to arduino nano. The Engineering Projects. Retrieved from <https://www.theengineeringprojects.com/2018/06/introduction-to-arduino-nano.html>
- Grokhotkov, I. (2017, July 24). ESP8266WiFi library¶. ESP8266WiFi library - ESP8266 Arduino Core documentation. Retrieved from <https://arduino-esp8266.readthedocs.io/en/latest/esp8266wifi/readme.html#introduction>
- Jiangsu Starlight Electricity Equipments Co. (2021, August 6). Reasons for oil leakage of diesel generator set. Diesel Generating Set, Emergency Diesel GeneratorsStarlight Generator. Retrieved from <https://www.dieselgeneratortech.com/diesel-engines/reasons-for-oil-leakage-of-diesel-generator-set.html>
- Stellar. (2021, October 4). Generator making noise (revving, funny, clicking, popping, knocking). Portable Power Guides. Retrieved from <https://portablepowerguides.com/generator-making-noise/>
- Clark, Jen. (2020, August 28). What is the internet of things, and how does it work? IBM Business Operations Blog, from <https://www.ibm.com/blogs/internet-of-things/what-is-the-iot/>
- Encyclopædia Britannica, inc. (2022, November 30). *Electricity generation*. Encyclopædia Britannica. Retrieved December 2, 2022, from <https://www.britannica.com/science/solar-energy/Electricity-generation>

- -Website Author Syed Zain Nasir syedzainnasir I am Syed Zain Nasir, Md. Mizanur Rahman Says: Steven Smiley Says: Alex1 Says: & Alex1 Says: (2021, December 13). *Introduction to arduino nano*. The Engineering Projects. Retrieved December 2, 2022, from <https://www.theengineeringprojects.com/2018/06/introduction-to-arduino-nano.html#:~:text=Arduino%20Nano%20comes%20with%20a,power%20source%20through%20a%20battery.>
- Church, Brian. (2022, June 10). Solar generators provide a sustainable source of backup electricity. ConsumerAffairs. Retrieved from <https://www.consumeraffairs.com/solar-energy/what-is-a-solar-generator.html>
- Ashok, S. (2022, November 30). Solar energy. Encyclopedia Britannica. Retrieved from <https://www.britannica.com/science/solar-energy>
- What is a project milestone? definition & examples: Teamgantt. RSS. (2021, April 1). Retrieved December 9, 2022, from <https://www.teamgantt.com/blog/the-how-and-why-of-using-milestones-in-your-project-plan>